



Product Catalogue

General Purpose 3-phase Induction Motors

**Energy Efficient
Motors
series 3SIE**



IE3

Certificates

Cantoni Motor SA
ISO 9001
Since September 30, 1999



Besel SA
ISO 9001
Since July 21, 1995

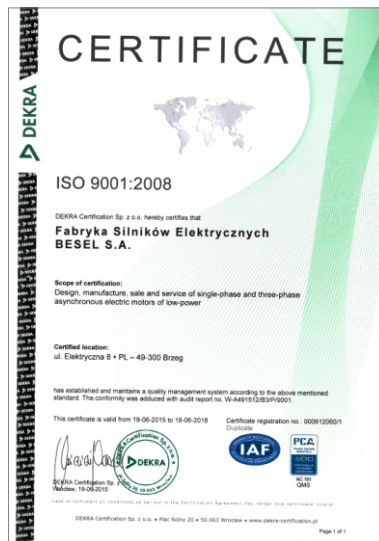

Celma Indukta SA
ISO 9001
Since April 1, 1993



ISO 14001
Since November 15, 1999

Emit SA
ISO 9001:2008
ISO 14001:2004
Since January 23, 2012

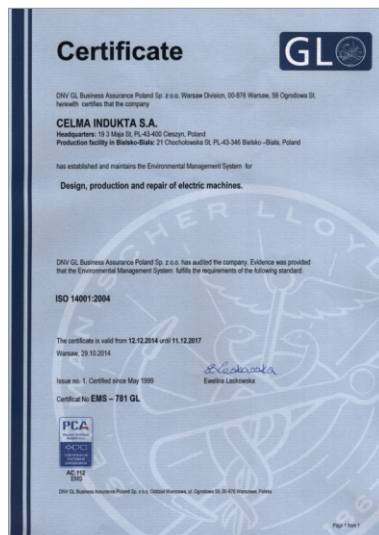



since 1948

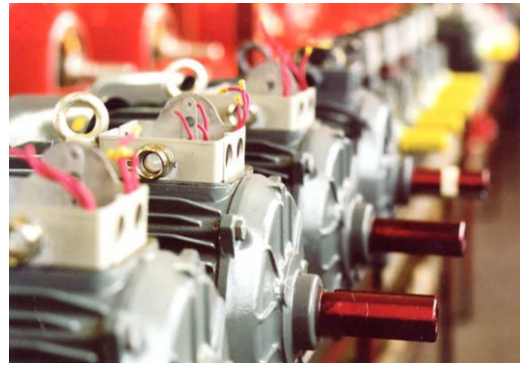

Product range beginning from 0,04kW up to 5000kW

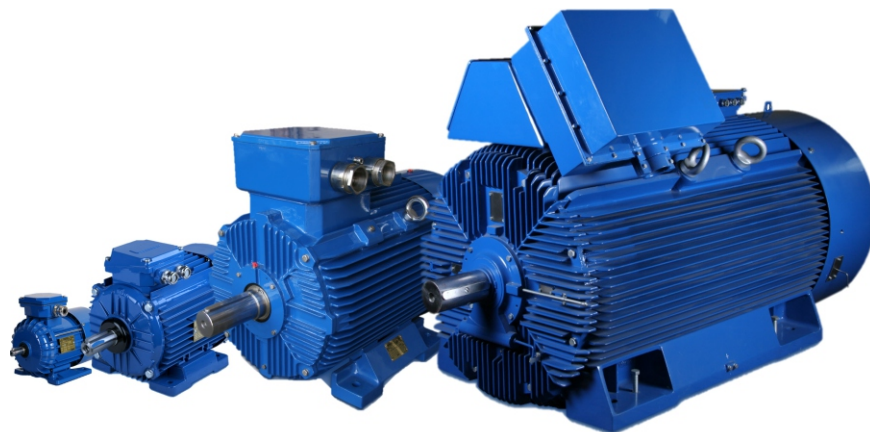

„FFD part of Cantoni Goup” in numbers

- ~ 1900 employees
- Annual production ~ 1.000.000 motors
- Covered area ~ 120.000 m²

OUR SOLUTION FOR YOUR POWER!

Contents

General information

pages 5-15

- Introduction to SIE motors*
- Efficiency of motors*
- Ratings-tolerances*
- Standards*
- Insulation classification*
- Terminal box*
- Vibration and noise level*
- Degree of protection*
- Mounting arrangements*
- Bearings*
- Permissible loads on the shaft end*
- Housing, endshields*
- Description of the customised executions*
- Ordering information*

Technical data

- 2 pole motors **page 16**
- 4 pole motors **page 17**
- 6 pole motors **page 18**
- 8 pole motors **page 19**
- 10 + 12 pole motors **page 20**

Dimensional drawings

pages 21-30

List of motor parts

pages 31-33

Production program

page 34+35

INTRODUCTION

New efficiency classes for the low-voltage three-phase motors (IE = International Efficiency).

Along with the international discussion on energy efficiency a worldwide harmonized energy efficiency standard classification system has been established for low-voltage three-phase asynchronous motors. For many years low-voltage three-phase motors in the European Union have been sold in three efficiency classes EFF3, EFF2 and EFF1. Aside from this, many different efficiency classification systems have been introduced and well-proven in many countries all over the world.

This was the reason for the International Electrotechnical Commission IEC to develop and publish an energy efficiency standard which replaces all previous national issues. In parallel IEC developed and issued a new standard for determining motor efficiency. The new standard IEC 60034-30-1 defines and harmonizes worldwide the efficiency classes IE1, IE2, IE3 and IE4 for low-voltage three-phase motors in the power range from 0.12 kW to 1000 kW (2p=2, 4, 6, 8)

IE1 = Standard Efficiency

IE2 = High Efficiency

IE3 = Premium Efficiency

According to IEC 60034-30-1 standard the efficiency has to be determined according to the new requirements given in the IEC 60034-2-1 standard.

According to the Commission Regulation (EC) No 640/2009 (introduced in July 2009) including Commission Regulation (EC) No 4/2014 the required efficiency class of general-purpose motors with 2p=2, 4, 6 (introduced to the market in the future) will be as follows:

From 1 January 2017: motors with a rated output between 0.75 - 375 kW shall have a minimum efficiency class of IE3, or IE2 if they are operated/equipped with electronic speed control (VSD).

Electronic speed control is carried out using a frequency converter (VSD) that adjusts the speed of the motor - and therefore the torque produced - based on the energy needed.

EFFICIENCY OF MOTORS

The present catalogue describes the electric motors which belong to the efficiency class IE3 (Premium Efficiency) and motors excluded from the Regulations (EC) 640/2009 and 4/2014 (motors with $2p = 8, 10, 12$ and with rated output below 0.75kW and above 375kW).

Comparison between the efficiency of FFD motors (for example $2p=4$) and efficiency class IE2/IE3 requirements according to the IEC 60034-30-1.

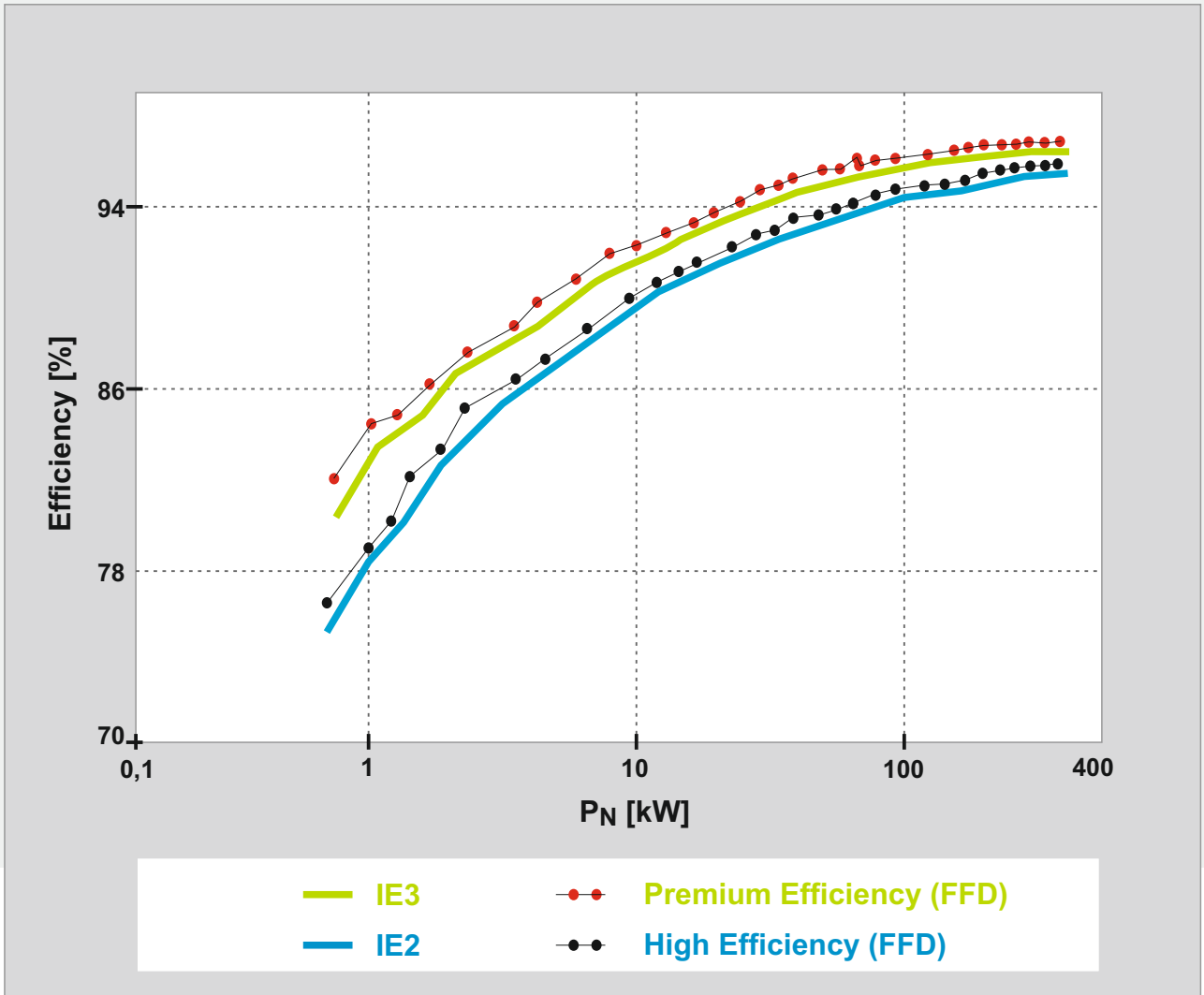

The efficiency class system specified under IEC 60034-30-1 is valid for low voltage three phase squirrel cage induction motors with the following specifications:

- Rated voltage up to 1.000 V
- Rated output between 0.12 kW and 1000 kW
- Either 2, 4, 6 or 8 poles
- Rated on the basis of continuous duty (S1)
- Supplied directly from mains
- With ambient temperature within the range of $-30^{\circ}\text{C} \div +60^{\circ}\text{C}$
- With altitude up to 4000 m. a.s.l.

Motors with flanges, feet and/or shafts with mechanical dimensions different from IEC 60072-1 are also covered by this standard.

RATINGS - TOLERANCES

Permissible deviations between real values and catalogue values according to the IEC 60034-1:

Power factor $\cos \varphi$	$\Delta \cos \varphi = -1/6 (1 - \cos \varphi_N)$
Efficiency η	$\Delta \eta = -15\% (100 - \eta_N)$ for $P_N \leq 150 \text{ kW}$ $\Delta \eta = -10\% (100 - \eta_N)$ for $P_N > 150 \text{ kW}$
Speed n	$\Delta n = \pm 20\% (n_s - n_N)$ for $P_N > 1 \text{ kW}$ $\Delta n = \pm 30\% (n_s - n_N)$ for $P_N \leq 1 \text{ kW}$
Locked rotor current I_L/I_N	$\Delta(I_L/I_N) = +20\% (I_L/I_N)$
Locked rotor torque T_L/T_N	$\min(T_L/T_N) = -15\% (T_L/T_N)$ $\max(T_L/T_N) = +25\% (T_L/T_N)$
Breakdown torque T_B/T_N	$\Delta(T_B/T_N) = -10\% (T_B/T_N)$
Moment of inertia J [kgm ²]	$\Delta J = \pm 10\% J$
Sound pressure level L_{pA} [dB]	$\Delta L_{pA} = +3 \text{ dB /A/}$

STANDARDS

The electric motors are manufactured according to the international standards:

Rating and performance	IEC 60034-1
Methods for determining losses and efficiency	IEC 60034-2-1
Classification of degrees of protection	IEC 60034-5
Methods of cooling	IEC 60034-6
Symbols of construction and mounting arrangements	IEC 60034-7
Terminal markings and direction of rotation	IEC 60034-8
Noise limits	IEC 60034-9
Dimensions and output of electric machines	IEC 60072-1
Vibration limits	IEC 60034-14

New IEC standards regarding efficiency classes (IEC 60034-30-1) and efficiency measurements (IEC 60034-2-1)

The resulting efficiency values differ from those obtained under the previous IEC 60034-2:1996 testing standard. It must be noted that the efficiency values are only comparable if they are obtained using the same measuring method.

EU Regulation 640/2009 and 4/2014 adapted on 6 January 2014

Commission Regulation 640/2009, adapted on 22 July 2009, specifies the requirements regarding the ecodesign of electric motors and the use of electronic speed control (VSD).

IE1
IE2
IE3

All the motors are manufactured according to Quality Assurance System consistent with ISO 9001.

ISO9001

The motors covered by the present catalogue comply with the regulations and standards effective in other countries, consistent with IEC standards.

IEC

All the motors described in the present catalogue are provided with CE mark.

CE

INSULATION CLASSIFICATION

The insulation system of an electric motor is determined by a given insulation class on the basis of its thermal resistance. This thermal resistance should be guaranteed by the entire set of electric insulating materials used in the motor insulating system.

Thermal resistance classification is related to the temperature of the hotspot in the insulation occurring during rated operating conditions of the electric motor, allowing for the highest permissible rise in average temperature.

This rise should be selected so that at the highest permissible ambient temperature, the temperature of the hotspot in insulation will not exceed the value assigned to a given thermal resistance class.

Symbols of thermal resistance classes (permissible insulation temperatures at 40°C ambient temperature)

Symbol	Temperature [°C]
A	105
E	120
B	130
F	155
H	180

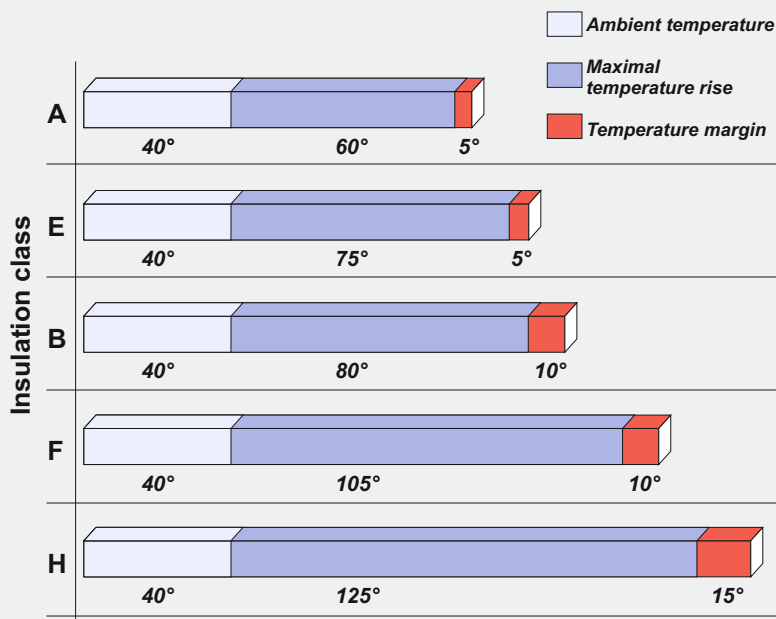

Insulation class F in an electric motor means that at ambient temperature of 40°C the temperature rise of the winding may be max. 105°C with the additional temperature margin of 10°C (under specified measuring conditions in accordance with the IEC 60034-1 standard).

Class F

The standard motors made by Cantoni Motor in their basic version have the insulation class F while the temperature rise is for class B. This means longer life for motors.

For special request we can deliver motors equipped with insulation class H.

Strengthened insulation system gives possibility to safe operation with frequency converters.

MOTOR FEET

Motors with frame size ≤ 132 have screwed feet.

Motors with frame size > 132 up to 315 have screwed feet or feet integrated with the motor housing.

Motors with frame size from 355 have feet integrated with the motor housing.

TERMINAL BOX

The terminal boxes of low voltage motors have threaded inlet holes designed for mounting cable glands. The box contains a terminal board with marked terminals making possible connection of supply cables.

In addition, terminal boxes may be provided with additional terminals connected to the ends of thermal protection or anticondensation heater circuits and extra glands to connect these circuits.

Low voltage high-power motors contain terminal boxes with cable gland seals.

The circuits of thermal protection and anticondensation heaters could be connected to separate terminal boxes.

Inside the boxes there are special clamps used to ground the supply cable armouring.

VIBRATION LEVEL AND NOISE LEVEL









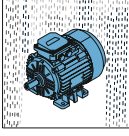
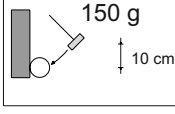

The rotor balancing method guarantees that a standard vibration level A is maintained in accordance with the IEC 60034-14 and a standard sound power level is maintained in accordance with the IEC 60034-9. On customer's demand the motors can be made with reduced vibration or noise level.

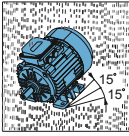
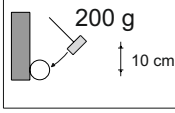
level A

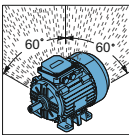
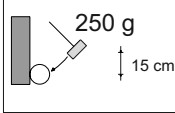
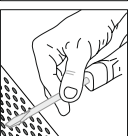
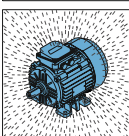
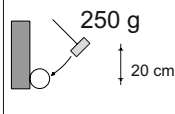
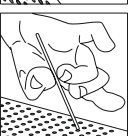
INTERNATIONAL PROTECTION MARKING IP

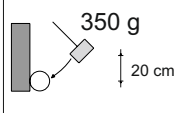
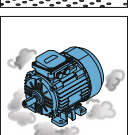
According to the IEC 60034-5 standard the electric motors are provided with IP code which determines the degree of protection (ensured by the housing) against penetration of solid matter and fluids.

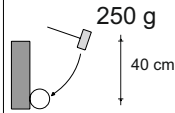
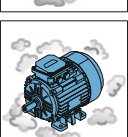
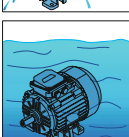
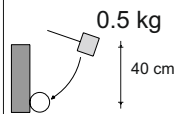
IP55

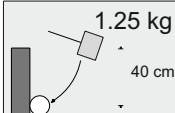
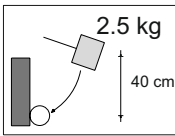
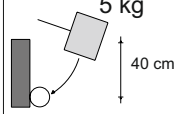
PROTECTION AGAINST PENETRATION OF SOLID MATTER		PROTECTION AGAINST PENETRATION OF FLUIDS		IK	MECHANICAL PROTECTION	
1st digit	DESCRIPTION	2nd digit	DESCRIPTION	3rd digit	DESCRIPTION	
				00	No protection	
0	 Not protected	0	 Not protected	01	 Striking energy: 0.15 J	
	 Protected against solid bodies larger than 50 mm		 Protected against vertically falling drops of water up to 15°		 Striking energy: 0.20 J	
	 Protected against solid bodies larger than 12 mm		 Protected against rain up to 60°		 Striking energy: 0.37 J	
	 Protected against solid bodies larger than 2.5 mm		 Protected against rain falling from any direction		 Striking energy: 0.50 J	
	 Protected against solid bodies larger than 1 mm		 Protected against sprayed water from any direction		 Striking energy: 0.70 J	
	 Protected against deposition of dust		 Protected against temporary immersion		 Striking energy: 1 J	
	 Totally protected against deposition of dust		 Protected against immersion between 0.15 and 1 m		 Striking energy: 2 J	
		8	 Protected against immersion at preset pressure and time		08	 Striking energy: 5 J
					09	 Striking energy: 10 J
					10	 Striking energy: 20 J

All „FFD part of Cantoni Group” standard motors are manufactured with IP 55 degree of protection according to the standard in force (IEC 60034-5). The following table lists its characteristics.



Each size 80 to 180 motor is equipped with seal rings (Simmerring or V-ring) on drive side and on non drive side. Labyrinth seals protect the motors from size 200 and above.

The terminal box is sealed with a gasket.

Motors with a higher degree of protection are available on request.

MOUNTING ARRANGEMENTS

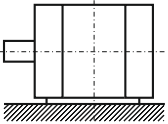
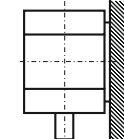
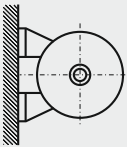
According to the IEC 60034-7 standard

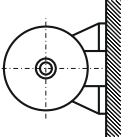
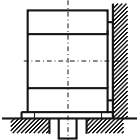
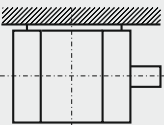
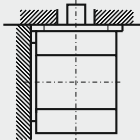
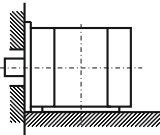
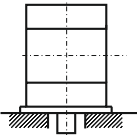
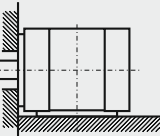
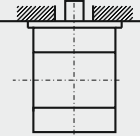
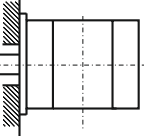
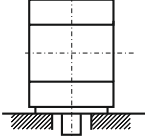
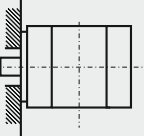
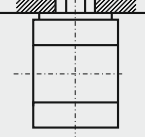
Horizontal shaft				Vertical shaft			
	Designation		Frame size		Designation		Frame size
	Code II	Code I			Code II	Code I	
	IM 1001	IM B3	56 ÷ 500		IM 1011	IM V5	56 ÷ 315 without 3SIE 315 M6B,C,D without SIE 315 M8C,D
	IM 1051	IM B6	56 ÷ 280		IM 1031	IM V6	56 ÷ 315 without 3SIE 315 M6B,C,D without SIE 315 M8C,D
	IM 1061	IM B7	56 ÷ 280		IM 2011 or IM 2111	IM V15	56 ÷ 355
	IM 1071	IM B8	56 ÷ 280		IM 2031 or IM 2131	IM V36	56 ÷ 355
	IM 2001	IM B35	56 ÷ 500		IM 3011	IM V1	56 ÷ 500
	IM 2101	IM B34	56 ÷ 132		IM 3031	IM V3	56 ÷ 280
	IM 3001	IM B5	56 ÷ 315 without 3SIEK 315 M6B,C,D without SIEK 315 M8C,D		IM 3611	IM V18	56 ÷ 180
	IM 3601	IM B14	56 ÷ 132		IM 3631	IM V19	56 ÷ 180

* Other mounting arrangements available on special request

PERMISSIBLE LOADS ON THE SHAFT END

Frame size	Number of poles	Horizontal operation		Vertical operation			Frame size	Number of poles	Horizontal operation		Vertical operation		
		$F_R(x=0)$	$F_R(x=\max)$	F_p	F_{a1}	F_{a2}			$F_R(x=0)$	$F_R(x=\max)$	F_p	F_{a1}	F_{a2}
		[kN]		[kN]					[kN]		[kN]		
DPIH 56	2	0,20	0,16	0,04	0,03	0,05	3SIE 200 LA	2	2,91	2,44	2,24	1,72	2,92
DPIH 56	4	0,25	0,20	0,05	0,04	0,06	3SIE 200 LB	2	2,85	2,39	2,23	1,67	2,93
DPIH 56	6	0,25	0,20	0,06	0,05	0,07	3SIE 200 L	4	3,61	3,03	2,81	2,12	3,70
DPIH 63	2	0,20	0,16	0,04	0,04	0,06	3SIE 200 LA	6	4,31	3,62	3,62	2,92	4,56
DPIH 63	4	0,25	0,20	0,06	0,05	0,07	3SIE 200 LB	6	4,06	3,40	3,54	2,71	4,65
DPIH 63	6	0,27	0,22	0,06	0,05	0,07	3SIE 225 S	4	4,18	3,40	3,19	2,42	4,16
DPIH 63	8	0,27	0,22	0,07	0,06	0,08	3SIE 225 M	2	3,31	2,81	2,53	1,93	3,29
DPIH 71	2	0,29	0,24	0,07	0,05	0,09	3SIE 225 M	4	3,97	3,23	3,13	2,26	4,24
DPIH 71	4	0,36	0,30	0,09	0,07	0,11	3SIE 225 M	6	4,57	3,72	3,98	2,95	5,33
DPIH 71	6	0,40	0,35	0,10	0,08	0,12	3SIE 250 M	2	4,09	3,39	3,11	2,33	4,13
DPIH 71	8	0,40	0,35	0,11	0,09	0,13	3SIE 250 M	4	4,90	4,06	3,85	2,68	5,36
3SIE 80(DPIH)	2	0,33	0,27	0,09	0,06	0,12	3SIE 250 M	6	5,92	4,90	4,99	3,81	6,55
3SIE 80(DPIH)	4	0,44	0,37	0,12	0,09	0,15	3SIE 280 S	2	3,94	3,34	3,07	2,01	4,43
DPIH 80	6	0,51	0,42	0,14	0,11	0,17	3SIE 280 S	4	6,69	5,67	5,01	3,65	6,77
DPIH 80	8	0,51	0,42	0,17	0,15	0,20	3SIE 280 S	6	7,86	6,67	5,79	4,32	7,70
3SIE 90	2	0,68	0,44	0,68	0,35	0,38	3SIE 280 M	2	3,80	3,22	3,03	1,89	4,49
3SIE 90	4	0,78	0,44	0,78	0,35	0,38	3SIE 280 M	4	6,15	5,22	4,86	3,16	7,04
3SIE 90	6	0,96	0,44	0,96	0,35	0,38	3SIE 280 M	6	7,69	6,52	5,75	4,19	7,75
3SIE 100	2	0,88	0,46	0,90	0,28	0,40	3SIE 315 S	2	3,56	3,08	2,96	1,63	4,69
3SIE 100	4	1,06	0,46	0,98	0,38	0,40	3SIE 315 S	4	5,75	4,82	4,74	2,71	7,37
3SIE 100	6	1,20	0,46	1,10	0,38	0,40	3SIE 315 S	6	7,21	6,04	5,61	3,84	8,14
3SIE 112	2	1,00	0,48	1,00	0,40	0,45	3SIE 315 MA	2	3,07	2,65	2,82	1,23	4,89
3SIE 112	4	1,45	0,48	1,40	0,40	0,45	3SIE 315 MB	2	2,67	2,31	2,71	0,91	5,05
3SIE 112	6	1,62	0,48	1,60	0,40	0,45	3SIE 315 MA	4	5,40	4,52	4,64	2,41	7,53
3SIE 132	2	1,82	0,66	1,90	0,43	0,60	3SIE 315 MB	4	5,16	4,33	4,58	2,20	7,64
3SIE 132	4	2,10	0,66	2,20	0,45	0,60	3SIE 315 MA	6	6,75	5,66	5,48	3,22	8,40
3SIE 132	6	2,80	0,66	2,80	0,50	0,60	3SIE 315 MB	6	6,27	5,33	5,34	2,68	8,78
3SIE 160	2	2,22	0,98	2,30	0,92	0,95	3SIE 315 MC	2	2,84	2,48	2,71	0,63	5,37
3SIE 160	4	2,40	0,98	2,40	0,92	0,95	3SIE 315 MC	4	6,27	5,33	4,34	1,46	8,06
3SIE 160	6	2,85	1,10	2,90	0,98	1,00	3SIE 315 MC	6	7,57	6,44	5,08	1,87	9,23
3SIE 180	2	2,92	1,30	3,00	1,10	1,20	3SIE 315 MD	6	7,47	6,36	5,05	1,82	9,22
3SIE 180	4	3,60	1,30	3,60	1,10	1,30							
3SIE 180	6	4,00	1,80	4,10	1,40	1,70							

PERMISSIBLE LOADS ON THE SHAFT END for motors 2DPIG (2p = 8 ÷ 12)

		$F_R(x=0)$	$F_R(x=\max)$	F_p	F_{a1}	F_{a2}			$F_R(x=0)$	$F_R(x=\max)$	F_p	F_{a1}	F_{a2}
		[kN]							[kN]				
2DPIG200L	8	5,10	4,20	4,10	3,40	5,00	2DPIG280S	8	8,30	6,90	6,60	5,20	8,50
2DPIG200LA	10	5,50	4,60	4,20	3,50	5,10	2DPIG280S	10	9,30	7,70	6,70	5,40	8,40
2DPIG200LB	10	5,50	4,50	4,10	3,40	5,10	2DPIG280S	12	9,80	8,10	7,00	5,70	8,70
2DPIG200L	12	5,90	4,90	4,40	3,70	5,40	2DPIG 280M	8	8,00	6,60	6,50	4,90	8,60
2DPIG225S	8	5,90	4,70	4,70	3,90	5,70	2DPIG280M	10	8,80	7,30	6,50	5,20	8,20
2DPIG225S	10	6,50	5,10	4,70	4,00	5,60	2DPIG280M	12	9,20	7,60	6,80	5,00	9,30
2DPIG225S	12	6,70	5,30	4,80	4,20	6,00	DPIG315S	8	8,40	7,00	7,00	5,00	9,60
2DPIG225M	8	5,70	4,60	4,60	3,70	5,80	DPIG315S	10	9,30	7,70	7,60	5,60	10,20
2DPIG225M	10	6,30	4,90	5,70	4,40	7,40	DPIG315S	12	9,80	8,10	8,00	5,90	10,80
2DPIG225M	12	6,70	5,30	4,90	3,90	6,20	DPIG315MA	8	8,20	6,80	6,90	4,80	9,70
2DPIG250M	8	6,90	5,60	5,60	4,30	7,20	DPIG315MB	8	7,70	6,40	6,80	4,30	10,00
2DPIG250M	10	7,50	6,20	5,70	4,40	7,40	DPIG315M	10	8,40	7,00	7,30	4,80	10,70
2DPIG250M	12	8,10	6,70	6,10	4,80	7,80	DPIG315MA	12	9,30	7,70	7,90	5,50	11,10
							DPIG315MB	12	9,10	7,60	7,80	5,30	11,20

VERSION WITH ROLLER BEARINGS for motors 355

Mechanical Size	Type of construction	No. of poles, 2p	D.E. bearing	N.D.E. bearing
3SIE 355 ML	IM1001 (B3)	4 ÷ 6	NU222 EM1C3	6222 C3
3SIE 355 H	IM1001 (B3)	4 ÷ 6	NU322 EM1C3	6322 C3

Horizontal mounting					
			Permissible radial forces		Permissible axial forces
			FX0	FXmax	FA
Motor type	Number of poles	Length of shaft extension E(mm)	kN	kN	kN
3SIE 355 ML	4	210	22	18	5
	6	210	23	15	5,5
3SIE 355 H	4	210	27	17	6
	6	210	29	15	7

VERSION WITH ROLLER BEARINGS for motors SEE355 and Sh355-500

Mechanical Size	Type of construction	No. of poles, 2p	D.E. bearing	N.D.E. bearing
SEE 355	IM1001 (B3)	8	NU222 EM1C3	6222 C3
Sh 355..s	IM1001 (B3)	4 ÷ 8	NU322 EM1C3	6322 C3
Sh 400..s	IM1001 (B3)	4 ÷ 10	on request	on request
Sh 450..s	IM1001 (B3)	4 ÷ 12	on request	on request
Sh 500..s	IM1001 (B3)	4 ÷ 10	on request	on request

Horizontal mounting						Vertical operation
			Permissible radial forces		Permissible axial forces	
			FX0	FXmax	FA	
Motor type	Number of poles	Length of shaft extension E(mm)	kN	kN	kN	
SEE 355	8	210	24	14	6	on request
Sh 355..s	4	210	27	17	6	on request
	8	210	30	15	8	on request
Sh 400 Sh 450 Sh 500	4 ÷ 8		on request			

PERMISSIBLE LOADS ON THE SHAFT END

Value of radial force F_R acting on the shaft end for a given belt pulley diameter is calculated according to the following formula:

$$F_R = \frac{19600 \times P \times k}{D_K \times n} \text{ [N]}$$

where: P - motor output [kW]
 D_K - belt pulley diameter [m]
 n - speed [rpm]
 k - belt tension factor:
 for V-belts $k=2,2$
 for flat belts $k=3$

Value of force F_R acting on any point of the shaft end (between points $X=\max$ and $X=0$) may be calculated according to the following formula:

$$F_R = F_{X0} - \frac{X}{E} \times (F_{X0} - F_{XMAX}) \text{ [N]}$$

where: F_{X0} - value of F_R force acting on the beginning of the shaft end
 F_{XMAX} - value of F_R force acting on the end of the shaft end
 E - length of the shaft end

Other specifications dependent on the frame size:

Frame size	Degree of protection	Position of the terminal box	Number of terminals	Number of cable outlets	Optional rotation of the terminal box	Glands	Temperature sensors in winding	Bearing lubrication on the run	Thermal protection of bearings
56	IP 55	top	6	1	180°	M 20	on request	no	no
63	IP 55	top	6	1	180°	M 20	on request	no	no
71	IP 55	top	6	1	180°	M 20	on request	no	no
80	IP 55	top	6	1	180°	M 20	on request	no	no
90	IP 55	top	6	2	180°	M 20	on request	no	no
100	IP 55	top	6	2	180°	M 20	on request	no	no
112	IP 55	top	6	2	180°	M 25	on request	no	no
132	IP 55	top	6	2	180°	M 25	on request	no	no
160	IP 55	top	6	2	180°	M 40	on request	on request	on request
180	IP 55	top	6	2	180°	M 40	on request	on request	on request
200	IP 55	top *	6	2	4 × 90°	M 50	PTC	yes	on request
225	IP 55	top *	6	2	4 × 90°	M 50	PTC	yes	on request
250	IP 55	top *	6	2	4 × 90°	M 63	PTC	yes	on request
280	IP 55	top *	6	2	4 × 90°	M 63	PTC	yes	on request
315	IP 55	top *	6	2	4 × 90°	M 76	PTC	yes	on request
355ML	IP 55	top	6	2	4 × 90°	M 76	PTC Mark A	yes	on request
355H	IP 55	top	6	2	4 × 90°	M 90	Pt 100	yes	Pt 100
400	IP 55	top	6 (bars)	3	180°	3×φ55	Pt 100	yes	Pt 100
450	IP 55	top	3 (bars)	3	180°	3×φ55	Pt 100	yes	Pt 100
500	IP 55	top	3 (bars)	3	180°	3×φ55	Pt 100	yes	Pt 100

* terminal box on right side for 2DPIG motors series ($2p = 8 \div 12$)

BEARINGS

Frame size	Number of poles	Bearings
DPIH 56	2 ÷ 6	6201 2Z
DPIH 63	2 ÷ 8	6202 2Z
DPIH 71	2 ÷ 8	6203 2Z
3SIE 80	2 ÷ 6	6204 2Z C3
3SIE 90	2 ÷ 6	6205 2Z C3
3SIE 100	2 ÷ 6	6206 2Z C3
3SIE 112	2 ÷ 6	6306 2Z C3
3SIE 132	2 ÷ 6	6308 2Z C3
3SIE 160	2 ÷ 6	6309 2Z C3
3SIE 180	2 ÷ 6	6311 2Z C3
3SIE 200	2 ÷ 6	6312 C3
3SIE 225	2 ÷ 6	6313 C3
3SIE 250	2 ÷ 6	6315 C3
3SIE 280	2	6315 C3
3SIE 280	4 ÷ 6	6318 C3
3SIE 315S,MA,MB	2	6315 C3
3SIE 315MC	2	6316 C3
3SIE 315S,MA,MB	4 ÷ 6	6318 C3
3SIE 315MC,MD	4 ÷ 6	6320 C3/6318 C3

The bearings in basic version of motors for horizontal and vertical duty, excluding 3SIE 315 with 2p=2.

BEARINGS for 2DPIG ($2p = 8 \div 12$)

Frame size	Number of poles	Bearings
2DPIG 200	8 ÷ 12	6312 C3
2DPIG 225	8 ÷ 12	6313 C3
2DPIG 250	8 ÷ 12	6315 C3
2DPIG 280	8 ÷ 12	6317 C3
DPIG 315	8 ÷ 12	6318 C3

Frame Size	Type of construction	No. of poles, 2p	D.E. bearing	N.D.E. bearing
3SIE 355 ML	IM1001 (B3)	2	6217 C3	6217 C3
3SIEL 355 ML	IM2001 (B35)	4 ÷ 6	6222 C3	6222 C3
3SIEK 355 ML	IM3011 (V1)	4 ÷ 6	6322 C3	6322 C3
3SIE 355 H	IM1001 (B3)	2	6217 C3	6217 C3
3SIEL 355 H	IM2001 (B35)	4 ÷ 6	6322 C3	6322 C3
3SIEK 355 H	IM3011 (V1)	4 ÷ 6	6322 C3	6322 C3

The bearings in basic version of motors for horizontal and vertical duty.

Frame Size	Type of construction	No. of poles, 2p	D.E. bearing	N.D.E. bearing
SEE 355	IM1001 (B3)	8	6222 C3	6222 C3
SLEE 355	IM2001 (B35)	8	6222 C3	6222 C3
SVEE 355	IM3011 (V1)	8	6322 C3	6322 C3
Sh 355..s	IM1001 (B3)	2	6217 C3	6217 C3
SLh 355..s	IM2001 (B35)	4 ÷ 8	6322 C3	6322 C3
SVh 355..s	IM3001 (V1)	4 ÷ 8	6322 C3	6322 C3
Sh 400..s	IM1001 (B3)	2	on request	
SLh 400..s	IM2001 (B35)	4 ÷ 10		
SVh 400..s	IM3011 (V1)	4 ÷ 10		
Sh 450..s	IM1001 (B3)	4 ÷ 12		
SLh 450..s	IM2001 (B35)	4 ÷ 12		
SVh 450..s	IM3011 (V1)	4 ÷ 12		
Sh 500..s	IM1001 (B3)	4 ÷ 10		
SLh 500..s	IM2001 (B35)	4 ÷ 10		
SVh 500..s	IM3011 (V1)	4 ÷ 10		

HOUSING, END SHIELDS, FEET

Frame size [mm]	Motor housing	End shields	Feet
56	Aluminium	Aluminium	Aluminium - screwed
63	Aluminium	Aluminium	Aluminium - screwed
71	Aluminium	Aluminium	Aluminium - screwed
3SIE 80	Aluminium	Aluminium	Aluminium - screwed
3SIE 90	Aluminium	Aluminium	Aluminium - screwed
3SIE100	Aluminium	Aluminium	Aluminium - screwed
3SIE 112	Aluminium	Cast iron	Aluminium - screwed
3SIE 132	Aluminium / cast iron	Cast iron	Aluminium - screwed
3SIE 160	Cast iron	Cast iron	Cast iron - screwed or integrated
3SIE 180	Cast iron	Cast iron	Cast iron - screwed or integrated
3SIE 200	Cast iron	Cast iron	Cast iron - screwed or integrated
3SIE 225	Cast iron	Cast iron	Cast iron - screwed or integrated
3SIE 250	Cast iron	Cast iron	Cast iron - screwed or integrated
3SIE 280	Cast iron	Cast iron	Cast iron - screwed or integrated
3SIE 315	Cast iron	Cast iron	Cast iron - screwed or integrated
355	Cast iron	Cast iron	Cast iron - integrated
400	Cast iron	Cast iron	Cast iron - integrated
450	Cast iron	Cast iron	Cast iron - integrated
500	Cast iron	Cast iron	Cast iron - integrated

In motors series DPIH, DPIG of frame size 80, 90 and 100mm: on request end shields may be made of cast iron.

In motors series 3SIE of frame size 80 and 90mm: on request end shields may be made of cast iron.

In motors of frame size 132: feet may be integrated with housing.

Motor housing

aluminium

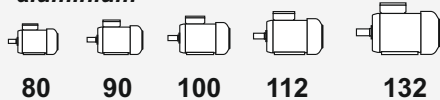

□ aluminium ■ cast iron

cast iron

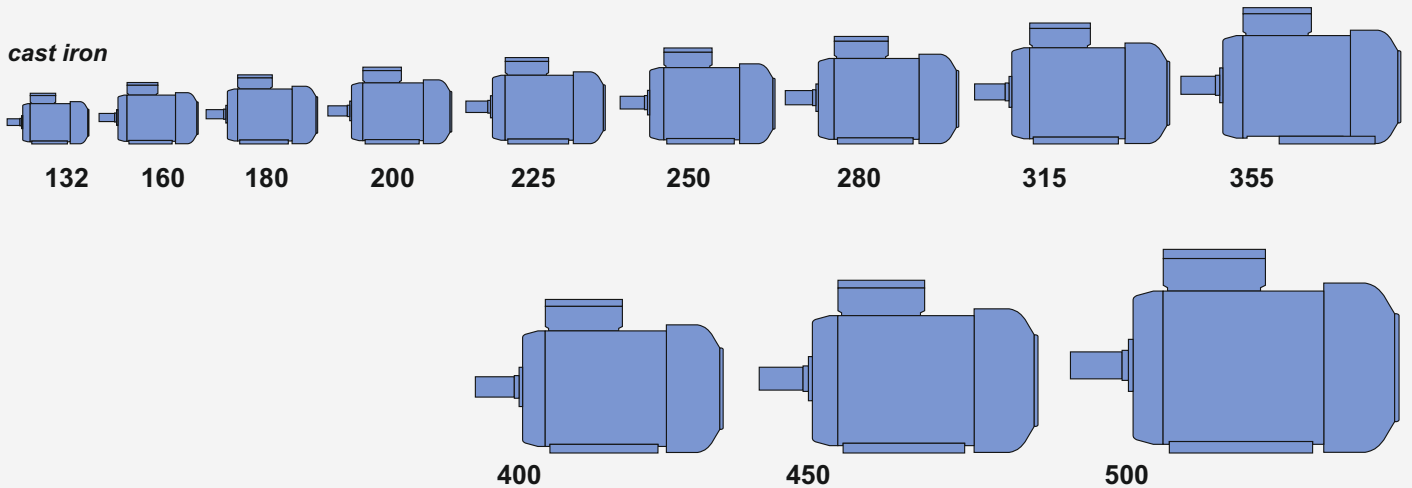

DESCRIPTION OF THE CATALOGUE VERSION

3SIE	315	M	4	B
(2)DPIG, DPIH, SEE	315	M	8	B

A = Lower power
 B = Higher power
 C,D = Increased Power

No. of poles
 (Speed)

Frame length
 L = long
 M = medium
 S = short

Shaft h
 (in B3)

3SIE
 (2)DPIG, DPIH, SEE

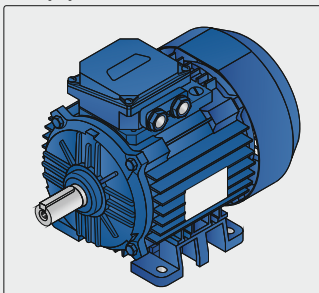

3SIEK
 (2)DPIG, DPIH, SVEE, SVh

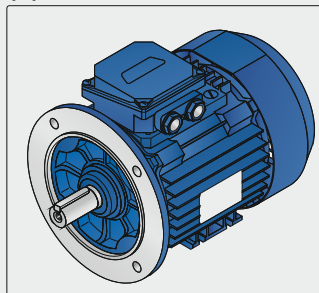

3SIEL
 (2)DPIG, DPIH, SLEE

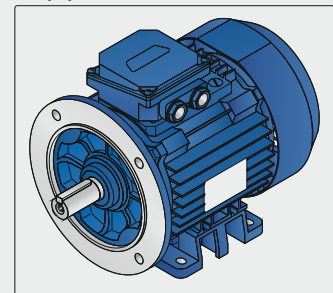

ORDERING INFORMATION

Orders for motors should specify:

- motor type designation,
- rated output,
- rated speed,
- operating duty,
- supply voltage and connection,
- frequency,
- mounting arrangements, end shield material,
- degree of protection,
- type of driven machine,
- other details regarding special requests,

and information concerning additional accessories e.g.

- thermal protection,
- anticondensation heaters,
- vibration sensors,
- etc.

When ordering high-power or special purpose motors one should also indicate:

- required direction of rotation,
- required degree of interior protection,
- method of start-up,
- method of coupling with the driven unit (gears, dimensions of belt pulleys, etc.),
- type of machine driven (nature of load), including the moment of inertia J or flywheel effect GD² brought to the motor shaft,
- other customer's specifications.

When ordering spare parts one should specify:

- full designation of the motor type including its serial number (provided on the nameplate) or catalogue number,
- degree of protection,
- mounting arrangement,
- name of part,
- number of pieces.

As part of our development program, we reserve the right to alter or amend any of the specifications without giving prior notice

Totally Enclosed Motors IP 55

Item	Type	Rated output		Rated speed	Rated torque	Efficiency			Power factor	Full load current			Locked rotor torque	Locked rotor current	Breakdown torque	Moment of Inertia	Weight	
		P_N				n_N	T_N	$\eta_N[\%]$			$\cos\phi_N$	I_N at rated voltage [A]						T_L/T_N
		[kW]	[HP]	[min ⁻¹]	[Nm]	50%	75%	100%	[-]	230V	380V	400V	[-]	[-]	[-]	[kgm ²]	[kg]	
				2p=2			$n_s=3000$ rpm			f=50Hz								
1	DPIH 56A/2	0,09	0,12	2820	0,30	45	52	62	0,63	0,60	0,35	0,35	2,5	3,4	2,7	0,000076	2,9	
2	DPIH 56B/2	0,12	0,17	2800	0,41	50	58	65	0,70	0,65	0,38	0,38	2,0	3,0	2,0	0,000095	3,2	
3	DPIH 63A/2	0,18	0,25	2760	0,62	63	68	70	0,77	0,85	0,50	0,50	2,1	3,4	2,1	0,000175	3,5	
4	DPIH 63B/2	0,25	0,33	2780	0,85	66	69	72	0,78	1,1	0,65	0,65	2,4	4,0	2,5	0,000235	4,1	
5	DPIH 71A/2	0,37	0,50	2800	1,25	67	69	71	0,77	1,75	1,0	1,0	2,2	4,4	2,2	0,000389	5,0	
6	DPIH 71B/2	0,55	0,75	2790	1,88	69	72	75	0,82	2,35	1,35	1,35	2,0	4,0	2,1	0,000484	6,0	
7	3SIE 80-2A	0,75	1	2850	2,5	79,0	82,0	82,0	0,82	2,85	1,65	1,65	3,8	6,3	3,8	0,00100	10,6	IE3
8	3SIE 80-2B	1,1	1,5	2840	3,7	82,0	83,0	83,0	0,86	3,8	2,2	2,2	3,7	6,9	3,8	0,00142	11,9	IE3
9	3SIE 90S2	1,5	2	2925	4,9	82,7	84,4	84,2	0,85	5,3	3,2	3,0	2,4	8,1	2,9	0,0014	16,5	IE3
10	3SIE 90L2	2,2	3	2910	7,2	85,4	86,5	85,9	0,86	7,5	4,5	4,3	2,7	8,0	4,0	0,0019	18,5	IE3
11	3SIE 100L2	3	4	2915	9,8	86,9	87,7	87,1	0,85	10,2	6,2	5,8	3,1	9,3	4,1	0,0039	25,01	IE3
12	3SIE 112M2	4	5,5	2925	13	88,0	88,5	88,1	0,89	12,8	7,8	7,4	2,3	8,4	3,2	0,0075	35,5	IE3
13	3SIE 132S2A	5,5	7,5	2940	17,9	87,7	89,2	89,2	0,89	17,4	10,5	10,0	2,6	8,2	3,4	0,014	55,0	IE3
14	3SIE 132S2B	7,5	10	2940	24,4	89,0	90,3	90,1	0,90	23,2	14,1	13,3	2,8	8,5	3,8	0,017	64,0	IE3
15	3SIE 160M2A	11	15	2945	35,7	89,7	91,0	91,2	0,90	33,6	20,4	19,2	2,2	7,3	3,2	0,048	123	IE3
16	3SIE 160M2B	15	20	2945	48,6	89,8	91,9	91,9	0,90	45,5	27,6	26,2	2,2	7,4	3,3	0,059	132	IE3
17	3SIE 160L2	18,5	25	2940	60,1	92,2	92,8	92,4	0,90	55,8	33,8	32,1	2,3	7,7	3,0	0,072	139	IE3
18	3SIE 180M2	22	30	2955	71,1	92,1	92,9	92,7	0,90	66,2	40,1	38,1	3,2	9,2	3,7	0,095	190	IE3
19	3SIE 200L2A	30	40	2965	97	93,1	93,7	93,5	0,90	89	54	51	2,4	7,0	2,8	0,19	275	IE3
20	3SIE 200L2B	37	50	2955	120	93,5	93,8	93,7	0,90	110	67	63	2,2	6,3	2,6	0,20	295	IE3
21	3SIE 225M2	45	60	2972	145	94,2	94,6	94,2	0,88	136	82	78	2,0	6,7	2,6	0,26	385	IE3
22	3SIE 250M2	55	75	2969	177	94,5	94,8	94,5	0,91	161	97	92	2,2	6,9	2,9	0,42	495	IE3
23	3SIE 280S2	75	100	2978	241	94,2	94,8	94,7	0,91	218	132	126	1,8	6,7	2,9	0,76	660	IE3
24	3SIE 280M2	90	125	2979	289	94,5	95,1	95,0	0,91	261	158	150	1,8	7,3	3,1	0,95	690	IE3
25	3SIE 315S2	110	150	2978	353	95,4	95,6	95,2	0,92	315	191	181	1,9	6,9	2,9	0,98	865	IE3
26	3SIE 315M2A	132	175	2977	423	95,8	95,9	95,6	0,92	377	238	217	2,0	7,3	2,7	1,28	970	IE3
27	3SIE 315M2B	160	220	2978	513	95,9	96,1	95,8	0,92	456	276	262	2,2	8,2	3,1	1,57	1118	IE3
28	3SIE 315M2C	200	270	2980	641	95,9	96,1	95,8	0,93	-	341	324	2,3	8,1	3,1	1,74	1185	IE3
29	3SIE 355 ML2A	250	340	2982	801	94,8	95,7	95,8	0,91	-	414	239	1,9	6,8	2,8	2,80	1620	IE3
30	3SIE 355 ML2B	315	430	2982	1009	95,5	96,1	96,2	0,91	-	519	300	2,0	7,3	2,9	3,00	1700	IE3
31	3SIE 355 H2D	355	480	2985	1136	95,2	96,0	96,2	0,91	-	585	338	1,8	7,5	2,8	4,90	2160	IE3
32	Sh 355H2Es	400	540	2985	1280	95,5	96,6	96,7	0,91	-	-	656	1,6	8,0	2,8	5,7	2160	
33	Sh 400H2Cs	450	610	2983	1441	95,5	96,3	96,5	0,91	-	-	741	1,3	6,6	2,6	6,7	2800	
34	Sh 400H2Ds	500	680	2985	1600	95,8	96,5	96,6	0,91	-	-	821	1,4	7,2	2,8	7,7	2800	
35	Sh 400H2Es	560	760	2989	1789	95,9	96,7	96,9	0,90	-	-	927	1,7	8,0	3,0	8,7	3100	
36	Sh 400H2Es	600	816	2987	1918	96,0	96,8	97,0	0,91	-	-	981	1,7	8,0	3,0	8,7	3100	

* insulation class F/F

Totally Enclosed Motors IP 55

Item	Type	Rated output		Rated speed	Rated torque	Efficiency			Power factor	Full load current			Locked rotor torque	Locked rotor current	Breakdown torque	Moment of Inertia	Weight
		P _N				η _N [%]	cos φ _N	I _N at rated voltage [A]									
		[kW]	[HP]	50%	75%			100%	230V	380V	400V	T _L /T _N	I _L /I _N	T _B /T _N	J	[kg]	
				2p=4		n_s=1500 rpm			f=50Hz								
37	DPIH 56A/4	0,06	0,08	1400	0,41	40,0	48,0	50,0	0,58	0,52	0,30	0,30	2,0	2,8	2,3	0,00015	2,6
38	DPIH 56B/4	0,09	0,12	1400	0,61	54,0	58,0	58,0	0,60	0,70	0,40	0,40	2,1	2,6	2,3	0,00019	2,8
39	DPIH 63A/4	0,12	0,17	1380	0,83	56,0	60,0	60,0	0,63	0,80	0,45	0,45	1,9	2,6	2,0	0,00024	3,5
40	DPIH 63B/4	0,18	0,25	1340	1,52	52,0	55,0	57,0	0,66	1,2	0,70	0,70	2,0	2,6	2,0	0,00031	4,1
41	DPIH 71A/4	0,25	0,33	1380	1,73	60,0	63,0	66,0	0,64	1,5	0,85	0,85	2,0	3,0	2,0	0,00061	5,1
42	DPIH 71B/4	0,37	0,50	1370	2,6	64,0	67,0	70,0	0,68	2,2	1,25	1,25	2,0	3,1	2,1	0,00077	5,8
43	DPIH 80-4A	0,55	0,75	1400	3,75	70,0	69,0	73,0	0,69	2,8	1,6	1,6	2,1	3,6	2,1	0,00158	7,5
IE3	44 3SIE 80-4B	0,75	1	1430	5,0	81,5	82,0	82,5	0,64	3,6	2,1	2,1	3,8	5,7	3,8	0,00265	11,0
IE3	45 3SIE 90S4	1,1	1,5	1450	7,2	81,8	84,0	84,1	0,77	4,3	2,6	2,5	2,5	7,6	3,1	0,0036	18,0
IE3	46 3SIE 90L4	1,5	2	1450	9,9	83,9	85,5	85,3	0,78	5,7	3,4	3,3	2,6	8,0	3,2	0,0040	21,0
IE3	47 3SIE 100L4A	2,2	3	1460	14,4	85,0	86,8	86,7	0,79	8,1	4,9	4,6	2,3	7,5	2,9	0,0076	27,5
IE3	48 3SIE 100L4B	3	4	1460	19,6	85,8	87,7	87,7	0,77	11,2	6,7	6,4	2,5	7,8	3,0	0,0086	31,0
IE3	49 3SIE 112M4	4	5,5	1460	26,2	88,5	89,0	88,6	0,80	14,2	8,6	8,1	2,1	7,1	3,1	0,0115	41,5
IE3	50 3SIE 132S4	5,5	7,5	1465	35,7	88,6	89,8	89,6	0,85	18,1	11,0	10,4	2,5	8,5	3,3	0,036	63,0
IE3	51 3SIE 132M4	7,5	10	1465	49,1	89,7	90,6	90,4	0,83	25,1	15,2	14,4	2,9	8,8	3,8	0,042	67,0
IE3	52 3SIE 160M4	11	15	1470	71,5	89,8	91,3	91,4	0,83	36,4	22,0	20,9	2,3	7,3	2,8	0,088	136
IE3	53 3SIE 160L4	15	20	1475	97,1	90,8	92,1	92,1	0,83	49,3	29,8	28,3	2,8	8,1	3,2	0,104	154
IE3	54 3SIE 180M4	18,5	25	1475	120,2	92,1	92,8	92,6	0,85	59,0	35,7	33,9	2,6	7,9	3,0	0,162	190
IE3	55 3SIE 180L4	22	30	1475	142,4	91,4	92,8	93,0	0,83	71,5	43,3	41,1	3,2	8,4	3,4	0,185	200
IE3	56 3SIE 200L4	30	40	1477	194	94,2	94,3	93,8	0,89	90	55	52	2,1	6,4	2,6	0,38	329
IE3	57 3SIE 225S4	37	50	1485	238	94,1	94,4	94,0	0,87	114	69	65	2,0	6,9	2,8	0,51	373
IE3	58 3SIE 225M4	45	60	1483	290	94,4	94,8	94,3	0,88	136	82	78	2,1	7,1	2,7	0,59	410
IE3	59 3SIE 250M4	55	75	1487	353	94,0	94,8	94,7	0,90	162	98	93	2,5	7,6	2,9	1,00	520
IE3	60 3SIE 280S4	75	100	1488	481	93,9	95,0	95,0	0,91	218	132	125	2,0	6,8	2,5	1,37	710
IE3	61 3SIE 280M4	90	125	1491	576	94,9	95,5	95,4	0,89	266	161	153	2,6	8,4	3,0	1,80	761
IE3	62 3SIE 315S4	110	150	1488	706	95,1	95,5	95,4	0,90	322	195	185	2,0	6,6	2,4	2,25	920
IE3	63 3SIE 315M4A	132	175	1489	847	95,6	95,9	95,6	0,91	381	231	219	2,3	7,9	2,8	2,59	1030
IE3	64 3SIE 315M4B	160	220	1490	1026	95,9	96,1	95,8	0,90	466	282	268	2,4	8,5	3,1	2,80	1130
IE3	65 3SIE 315M4C	200	270	1488	1284	95,8	96,2	96,2	0,90	-	351	333	2,4	8,1	2,9	3,46	1205
IE3	66 3SIE 355 ML4A	250	340	1489	1603	95,6	96,1	96,1	0,89	-	422	244	2,0	7,4	2,3	5,30	1700
IE3	67 3SIE 355 ML4B	315	430	1489	2020	96,0	96,4	96,3	0,90	-	525	303	2,3	7,5	2,5	6,40	1830
IE3	68 3SIE 355 H4D	355	480	1488	2278	96,1	96,4	96,3	0,88	-	605	349	1,7	6,4	2,2	7,80	2200
69	Sh 355H4Es	400	540	1489	2566	96,4	96,8	96,7	0,88	-	715	678	1,8	7,0	2,3	8,7	2275
70	Sh 400H4Cs	450	610	1490	2884	96,3	96,9	96,9	0,88	-	796	762	1,6	7,6	2,6	12,3	2920
71	Sh 400H4Ds	500	680	1491	3203	96,2	96,7	96,7	0,88	-	891	848	1,6	7,5	2,6	13,6	3100
72	Sh 400H4Es	560	760	1491	3587	96,6	97,0	97,0	0,87	-	987	958	1,7	7,6	2,6	15,0	3220
73	Sh 400H4Fs	630	850	1491	4035	96,7	97,1	97,1	0,87	-	1114	1076	1,9	8,4	2,8	16,5	3440
74	Sh 450H4Bs	710	960	1492	4545	96,6	97,1	97,1	0,88	-	-	696 ²	1,6	7,0	2,5	27,1	4000
75	Sh 450H4Cs	800	1080	1494	5114	96,8	97,1	97,1	0,89	-	-	774 ²	1,6	6,8	2,6	31,6	4400
76	Sh 450H4Ds	900	1210	1493	6757	96,8	97,2	97,2	0,88	-	-	881 ²	1,0	7,3	2,5	35,4	4620
77	Sh 450H4Es	1000	1350	1493	6397	96,8	97,3	97,3	0,89	-	-	966 ²	1,5	7,3	2,5	38,0	4700
78	Sh 500H4Cs	1120	1510	1495	7155	96,7	97,4	97,4	0,87	-	-	1107 ²	0,8	6,9	2,5	58,4	6100
79	Sh 500H4Ds	1250	1680	1495	7985	96,7	97,4	97,5	0,87	-	-	1234 ²	0,8	7,5	2,7	65,2	6600
80	Sh 500H4Es	1400	1880	1494	8949	96,9	97,5	97,5	0,88	-	-	1367 ²	0,7	6,4	2,4	66,5	6900

2 - at rated voltage 690V

Totally Enclosed Motors IP 55

Item	Type	Rated output		Rated speed n_N [min ⁻¹]	Rated torque T_N [Nm]	Efficiency			Power factor $\cos\phi_N$ [-]	Full load current			Locked rotor torque T_L/T_N [-]	Locked rotor current I_L/I_N [-]	Breakdown torque T_B/T_N [-]	Moment of Inertia J [kgm ²]	Weight [kg]	
		P_N				η_N [%]				I_N at rated voltage [A]								
		[kW]	[HP]			50%	75%	100%		230V	380V	400V						
				2p=6		$n_s=1000$ rpm			f=50Hz									
81	DPIH 56B/6	0,06	0,08	870	0,64	44	46	50	0,65	1,1	0,65	0,65	1,3	1,8	1,5	0,00019	2,8	
82	DPIH 63A/6	0,09	0,12	820	1,05	26	32	40	0,75	0,8	0,45	0,45	1,15	1,9	1,3	0,00024	3,5	
83	DPIH 63B/6	0,12	0,17	870	1,30	38	44	50	0,65	1,15	0,65	0,65	1,3	1,8	1,1	0,00031	4,1	
84	DPIH 71A/6	0,18	0,25	890	1,93	47	54	57	0,68	1,3	0,75	0,75	1,9	2,6	1,9	0,00074	4,8	
85	DPIH 71B/6	0,25	0,33	860	2,78	45	52	55	0,79	1,75	1,0	1,0	1,6	2,0	1,6	0,00095	5,6	
86	DPIH 80A/6	0,37	0,50	910	3,88	61	63	64	0,65	2,4	1,4	1,4	2,0	3,0	2,1	0,00169	7,4	
87	DPIH 80B/6	0,55	0,75	900	5,84	62	65	67	0,70	3,1	1,8	1,8	1,9	2,7	2,0	0,00207	8,7	
88	3SIE 90S6	0,75	1	940	7,6	77,2	79,3	78,9	0,71	3,4	2,0	1,9	2,1	4,5	2,6	0,0032	16	IE3
89	3SIE 90L6	1,1	1,5	940	11,1	79,9	81,9	81,0	0,70	4,9	2,9	2,8	2,1	4,5	2,6	0,0090	19	IE3
90	3SIE 100L6	1,5	2	960	14,9	81,1	82,8	82,5	0,74	6,2	3,7	3,5	2,6	6,2	3,3	0,0100	23,5	IE3
91	3SIE 112M6	2,2	3	960	21,9	83,9	84,9	84,3	0,76	8,6	5,2	5,0	2,1	5,9	2,6	0,0177	34	IE3
92	3SIE 132S6	3	4	965	29,7	85,0	87,2	87,0	0,81	10,7	6,5	6,1	2,2	6,6	2,9	0,0440	54	IE3
93	3SIE 132M6A	4	5,5	965	39,8	89,1	89,2	88,0	0,81	14,1	8,5	8,1	2,3	6,6	3,0	0,0579	62	IE3
94	3SIE 132M6B	5,5	7,5	960	54,7	88,9	89,1	88,0	0,81	19,4	11,7	11,1	2,4	6,7	3,1	0,0637	66	IE3
95	3SIE 160M6	7,5	10	970	73,8	89,0	89,9	89,5	0,82	25,7	15,5	14,8	2,1	6,8	2,9	0,1020	134	IE3
96	3SIE 160L6	11	15	970	108,3	89,6	90,5	90,3	0,82	37,3	22,6	21,4	2,2	7,0	3,0	0,1230	146	IE3
97	3SIE 180L6	15	20	980	146,2	90,0	91,3	91,2	0,81	60,0	30,9	29,3	3,3	7,3	2,8	0,2760	198	IE3
98	3SIE 200L6A	18,5	25	988	179	91,3	92,0	91,7	0,81	63	38	36	2,0	5,8	2,4	0,50	285	IE3
99	3SIE 200L6B	22	30	987	213	91,7	92,2	92,2	0,82	73	44	42	2,0	5,7	2,1	0,64	309	IE3
100	3SIE 225M6	30	40	989	290	92,3	92,9	92,9	0,83	98	53	55	1,9	6,4	2,3	0,89	392	IE3
101	3SIE 250M6	37	50	991	357	92,2	93,4	93,3	0,82	121	73	70	2,0	6,7	2,6	1,23	440	IE3
102	3SIE 280S6	45	60	993	433	92,9	93,8	93,7	0,81	149	90	86	2,3	7,3	2,6	1,70	635	IE3
103	3SIE 280M6	55	75	992	529	93,8	94,4	94,1	0,82	179	108	103	2,3	6,8	2,6	1,90	695	IE3
104	3SIE 315S6	75	100	992	722	94,6	95,0	94,7	0,82	242	147	139	2,4	7,1	2,6	2,40	900	IE3
105	3SIE 315M6A	90	125	993	866	95,1	95,4	95,1	0,82	290	175	167	2,6	7,6	2,7	2,93	965	IE3
106	3SIE 315M6B	110	150	992	1059	95,2	95,6	95,2	0,82	354	214	203	2,8	7,5	2,8	3,46	1110	IE3
107	3SIE 315M6C	132	175	992	1271	95,4	95,8	95,4	0,83	-	253	241	2,5	7,0	2,5	4,21	1230	IE3
108	3SIE 315M6D	160	220	992	1540	95,2	95,7	95,6	0,78	-	310	180	3,3	8,0	2,7	4,36	1235	IE3
109	3SIE 355 ML6A	200	270	989	1931	95,3	95,9	95,8	0,86	-	350	202	2,0	7,1	2,3	7,20	1740	IE3
110	3SIE 355 ML6B	250	340	990	2412	95,5	96,0	95,8	0,86	-	438	253	2,1	7,2	2,4	8,60	1950	IE3
111	3SIE 355 H6C	315	430	992	3033	96,0	96,3	96,1	0,86	-	550	318	2,0	7,1	2,2	12,70	2390	IE3
112	3SIE 355 H6D	355	480	991	3421	95,9	96,3	96,1	0,86	-	620	358	1,9	7,0	2,3	13,60	2500	IE3
113	Sh 400H6Bs	400	540	992	3851	95,6	96,3	96,3	0,84	-	-	714	1,7	6,8	2,2	18,2	3050	
114	Sh 400H6Cs	450	610	993	4328	95,8	96,3	96,0	0,83	-	-	815	1,5	7,5	2,5	19,4	3250	
115	Sh 450H6As	500	680	994	4804	96,6	96,9	96,8	0,88	-	-	491 ²	1,2	6,7	2,6	36,5	3800	
116	Sh 450H6Bs	560	760	994	5380	96,7	97,0	96,9	0,88	-	-	549 ²	1,2	6,8	2,6	40,6	4300	
117	Sh 450H6Cs	630	850	994	6053	96,7	97,1	97,0	0,89	-	-	611 ²	1,3	7,0	2,6	45,0	4500	
118	Sh 450H6Ds	710	960	994	6821	96,5	96,8	96,8	0,89	-	-	690 ²	1,4	7,4	2,6	50,0	4890	
119	Sh 500H6As	800	1080	995	7678	96,7	97,1	97,0	0,86	-	-	802 ²	0,9	5,8	2,4	61,5	6200	
120	Sh 500H6Bs	900	1210	995	8638	96,8	97,1	97,0	0,87	-	-	893 ²	1,0	6,0	2,2	67,5	6550	
121	Sh 500H6Cs	1000	1350	995	9598	96,4	97,0	97,1	0,86	-	-	1002 ²	1,0	6,4	2,5	70,0	6700	
122	Sh 500H6Ds	1120	1510	996	10739	96,4	97,1	97,2	0,85	-	-	1134 ²	1,1	7,0	2,6	80,0	7130	
123	Sh 500H6Es	1250	1680	996	11985	96,4	97,1	97,2	0,85	-	-	1266 ²	1,1	7,1	2,6	84,6	7460	

2 - at rated voltage 690V

Totally Enclosed Motors IP 55

Item	Type	Rated output		Rated speed	Rated torque	Efficiency			Power factor	Full load current			Locked rotor torque	Locked rotor current	Breakdown torque	Moment of inertia	Weight (IMB3)
		P_N				n_N	T_N	η_N [%]			$\cos\phi_N$	I_N at rated voltage					
		[kW]	[HP]	[min ⁻¹]	[Nm]	50%	75%	100%	[-]	[A] _{230V}	[A] _{380V}	[A] _{400V}	[-]	[-]	[-]	[kgm ²]	[kg]
2p=8 n_s=750 rpm																	
124	DPIH 63A/8	0,04	0,05	670	0,57	20	31	35	0,60	0,6	0,35	0,35	1,6	1,7	1,7	0,00024	3,5
125	DPIH 63B/8	0,06	0,08	660	0,87	20	24	28	0,48	1,1	0,65	0,65	1,4	1,5	1,6	0,000307	4,1
126	DPIH 71A/8	0,09	0,12	680	1,26	25	31	35	0,5	1,3	0,75	0,75	1,9	1,9	1,9	0,000736	4,7
127	DPIH 71B/8	0,12	0,17	670	1,71	40	45	47	0,63	1,25	0,7	0,7	1,7	1,9	1,8	0,000946	5,6
128	DPIH 80A/8	0,18	0,25	680	2,53	43	51	53	0,57	1,55	0,9	0,9	1,8	2,3	2,0	0,001693	7,2
129	DPIH 80B/8	0,25	0,33	680	3,51	52	55	57	0,6	2,1	1,2	1,2	1,7	2,5	1,7	0,00207	8,7
130	DPIH 90S/8	0,37	0,5	695	5,08	54,2	60,8	63,4	0,59	2,5	1,5	1,4	1,7	2,9	2,3	0,0021	13,4
131	DPIH 90L/8	0,55	0,75	675	7,78	60,4	65,3	65	0,64	3,3	2	1,9	1,7	2,8	1,9	0,0024	15,3
132	DPIG 100LA/8	0,75	1	710	10,1	65,9	70,5	71,1	0,66	4	2,4	2,3	1,4	3,5	1,9	0,009	23,6
133	DPIG 100LB/8	1,1	1,5	705	14,9	67,6	71,8	72,2	0,65	5,9	3,6	3,4	1,6	3,6	1,9	0,01	26,3
134	DPIG 112M/8	1,5	2	720	19,9	72,5	76,2	76,8	0,71	6,9	4,2	4,0	1,9	4,6	2,3	0,0192	31
135	2DPIG 132S/8	2,2	3	710	29,6	75,4	78,2	78	0,74	9,6	5,8	5,5	2,0	4,7	2,4	0,033	53
136	2DPIG 132M/8	3	4	710	40,4	78,5	80,7	80	0,74	12,7	7,7	7,3	2,3	5,0	3,0	0,044	65
137	DPIG 160MA/8	4	5,5	705	54,2	81,5	82,7	81,5	0,76	16,2	9,8	9,3	2,2	5,0	2,7	0,06	85
138	DPIG 160MB/8	5,5	7,5	710	74	82,1	83,7	83	0,75	22,2	13,4	12,8	2,7	5,5	3,0	0,077	95
139	DPIG 160L/8	7,5	10	705	102	84,5	85,5	84,5	0,78	28,6	17,3	16,4	2,7	5,8	3,0	0,102	115
140	DPIG 180L/8	11	15	730	144	87,7	89,2	89	0,76	40,8	24,7	23,5	2,0	5,5	2,4	0,213	165
141	2DPIG 200L/8	15	20	733	195	88,8	90	89,5	0,83	51	30,5	29,1	2,2	5,5	2,1	0,45	255
142	2DPIG 225S/8	18,5	25	735	240	88,8	90	89,5	0,81	64	39	37	2,0	5,6	2,0	0,58	280
143	2DPIG 225M/8	22	30	735	286	90,0	90,8	90,4	0,80	76	46	44	2,0	5,2	1,8	0,68	315
144	2DPIG 250M/8	30	40	738	388	91,0	92	91,5	0,84	98	59	56	2,5	6,3	2,1	1,27	430
145	2DPIG 280S/8	37	50	737	479	92,0	93,1	92,8	0,83	121	73	69	2,0	5,3	1,8	1,47	535
146	2DPIG 280M/8	45	60	737	583	92,0	92,8	92,5	0,84	145	88	84	2,1	5,4	2,0	1,8	590
147	DPIG 315S/8	55	75	735	715	92,0	93,0	92,7	0,81	184	111	106	2,0	5,3	1,9	2,16	720
148	DPIG 315MA/8	75	100	737	972	92,5	93,5	93,2	0,82	246	149	142	2,5	6,2	1,9	2,29	750
149	DPIG 315MB/8	90	125	737	1166	92,5	93,5	93,2	0,82	296	179	170	2,4	6,5	1,9	2,86	840
150	SIE 315M8C ¹	110	150	737	1425	92,3	93,1	93,3	0,79	375	227	215	2,3	5,4	2,2	3,46	1105
151	SIE 315M8D ¹	132	175	734	1717	92,7	93,3	93,2	0,81	439	266	252	2,3	5,4	2,2	3,69	1136
152	SEE 355ML8A	160	220	739	2068	95,1	95,5	95,0	0,80	-	-	305	1,6	5,8	2,0	7,0	1680
153	SEE 355ML8B	200	270	740	2581	95,1	95,6	95,2	0,79	-	-	384	1,8	6,2	2,1	7,7	1750
154	Sh 355H8Ds	250	340	742	3218	95,5	96,0	95,6	0,78	-	-	484	1,3	6,0	2,0	12,9	2440
155	Sh 355H8Es	315	430	742	4054	95,6	96,0	95,8	0,78	-	-	609	1,3	6,0	2,0	16,0	2590
156	Sh 400H8Ds	355	480	742	4569	95,3	95,9	95,9	0,77	-	-	695	1,2	5,8	2,0	18,8	3200
157	Sh 400H8Es	400	540	742	5148	95,4	96,0	96,0	0,77	-	-	782	1,2	5,9	2,0	21,0	3350
158	Sh 450H8Bs	450	610	746	5761	95,5	96,3	96,4	0,78	-	-	501 ²	1,0	5,8	2,1	41,6	4400
159	Sh 450H8Cs	500	680	746	6401	95,5	96,3	96,4	0,78	-	-	557 ²	1,0	5,8	2,1	46,0	4600
160	Sh 450H8Ds	560	760	746	7169	95,6	96,4	96,5	0,78	-	-	623 ²	1,0	5,7	2,1	49,0	4770
161	Sh 450H8Es	630	850	746	8065	95,8	96,4	96,5	0,79	-	-	692 ²	1,0	5,6	2,0	53,8	4980
162	Sh 500H8Bs	710	960	746	9089	96,0	96,6	96,7	0,81	-	-	758 ²	1,0	6,0	2,4	92,4	6680
163	Sh 500H8Cs	800	1080	746	10241	96,0	96,6	96,7	0,80	-	-	865 ²	1,1	6,3	2,5	95,8	6800
164	Sh 500H8Ds	900	1210	746	11522	96,1	96,8	96,9	0,80	-	-	971 ²	1,0	6,0	2,4	108	7240
165	Sh 500H8Es	1000	1350	746	12802	96,1	96,8	96,9	0,80	-	-	1079 ²	1,1	6,5	2,5	118	7570

¹ insulation class H

² at rated voltage 690 V

Totally Enclosed Motors IP 55

Item	Type	Rated output		Rated speed	Rated torque	Efficiency			Power factor	Full load current			Locked rotor torque	Locked rotor current	Breakdown torque	Moment of inertia	Weight (IMB3)
		P_N	P_N			η_N	T_N	η_N [%]		$\cos\phi_N$	I_N at rated voltage						
		[kW]	[HP]	[min ⁻¹]	[Nm]	50%	75%	100%	[-]	[A] _{230V}	[A] _{380V}	[A] _{400V}	[-]	[-]	[-]	[kgm ²]	[kg]
2p=10 $n_s=600$ rpm																	
166	2DPIG 200LA/10	7,5	10	580	123	82,5	84	85	0,68	32,5	19,7	18,7	1,7	3,5	2,1	0,4	240
167	2DPIG 200LB/10	11	15	590	178	84,7	86,7	87,5	0,68	46,5	28,1	26,7	3,2	5,9	2,4	0,47	255
168	2DPIG 225S/10	13	18	592	210	87,5	89,3	90,5	0,67	54	32,5	31	1,8	3,8	2	0,6	280
169	2DPIG 225M/10	15	20	590	243	86	88	89	0,67	63	38	36,5	2,8	5,4	2	0,76	315
170	2DPIG 225M/10z	18,5	25	590	299	84,3	87,1	87,7	0,64	83	50	47,5	2,8	5,5	2,1	0,76	325
171	2DPIG 250M/10	22	30	592	355	87,5	89,6	90	0,70	88	53	50	3	5,8	2	1,27	430
172	2DPIG 280SA/10	30	40	586	489	85,3	87,3	88,8	0,71	119	72	69	2	4,5	1,7	1,35	525
173	2DPIG 280SB/10	37	50	583	606	87	90	91	0,75	136	82	78	1,9	4,5	1,5	1,61	565
174	2DPIG 280M/10	45	60	587	732	88	90,5	91,6	0,76	162	98	93	2	4,5	1,6	2,03	630
175	DPIG 315S/10	45	60	588	731	90	91,5	92,1	0,71	173	105	99	2	4,1	2	2,16	720
176	DPIG 315S/10z	55	75	583	901	88	90,5	91,5	0,75	201	122	116	1,7	4,7	1,9	2,86	840
177	DPIG 315M/10	75	100	583	1229	88	90,5	91,5	0,75	274	166	158	1,8	4,9	1,5	3,01	895
178	Sh 400H10As	200	270	594	3216	94,4	95,1	95,0	0,82	-	-	371	1,0	5,4	2,5	25,6	3010
179	Sh 400H10Bs	250	340	594	4019	94,4	95,2	95,2	0,79	-	-	480	1,1	5,6	2,6	31,3	3270
180	Sh 450H10As	315	430	594	5064	94,9	95,5	95,5	0,81	-	-	341 ²	1,0	5,9	2,2	49,4	4050
181	Sh 450H10Bs	355	480	594	5708	95,0	95,7	95,7	0,81	-	-	384 ²	1,0	6,0	2,3	53,9	4130
182	Sh 450H10Cs	400	540	594	6431	95,0	95,7	95,7	0,81	-	-	432 ²	1,1	6,4	2,3	58,3	4300
183	Sh 500H10As	450	610	594	7235	95,1	95,8	95,7	0,81	-	-	486 ²	1,4	6,3	2,1	74,1	5420
184	Sh 500H10Bs	500	680	594	8039	95,2	95,9	95,8	0,82	-	-	533 ²	1,5	6,6	2,2	85,5	5700
185	Sh 500H10Cs	560	760	593	9019	95,4	95,9	95,8	0,82	-	-	597 ²	1,3	6,2	2,0	94,2	5950
186	Sh 500H10Ds	630	850	594	10129	95,5	96,0	96,0	0,82	-	-	670 ²	1,7	6,9	2,2	108	6400
2p=12 $n_s=500$ rpm																	
187	2DPIG 200L/12	9	12	490	175	75,3	80,1	81,8	0,55	50	30,5	28,9	2,7	4,3	2,5	0,47	255
188	2DPIG 225S/12	11	15	490	214	83,1	85,0	86,0	0,63	51	31	29,3	1,7	3,5	1,7	0,58	315
189	2DPIG 225M/12	13	18	475	261	81,5	82,2	82,5	0,59	67	40,5	38,5	1,7	3,5	1,7	0,68	320
190	2DPIG225M/12z	15	20	491	292	80,5	83,5	84,4	0,58	77	46,5	44	2,7	4,6	1,8	0,68	350
191	2DPIG 250M/12	18,5	25	490	361	84,0	86,0	87,8	0,65	81	49,5	47	1,7	3,5	1,8	1,27	430
192	2DPIG 280S/12	22	30	491	428	86,9	89,2	89,6	0,61	101	61	58	2,3	4,5	1,8	1,47	535
193	2DPIG 280M/12	30	40	490	585	85,6	88,2	89,0	0,62	136	83	78	1,8	3,5	1,8	1,8	570
194	DPIG 315S/12	37	50	492	718	87,5	89,9	90,4	0,58	177	107	102	2,6	4,5	1,9	2,29	730
195	DPIG 315MA/12	45	60	490	877	87,9	89,0	90,1	0,58	216	131	124	2	3,5	1,8	2,86	870
196	DPIG 315MB/12	55	75	490	1072	87,5	90,0	89,5	0,58	266	161	153	2,5	4,4	1,8	3,01	885
197	Sh 450H12As	160	220	495	3087	94,1	95,0	95,0	0,79	-	-	308	0,9	5,9	2,6	30,0	3470
198	Sh 450H12Bs	200	270	495	3859	94,7	94,9	94,9	0,80	-	-	381	0,9	5,7	2,3	33,7	3600
199	Sh 450H12Cs	250	340	493	4843	94,7	95,0	94,7	0,82	-	-	465	0,8	5,1	2,2	40,0	3750

² - at rated voltage 690 V

As part of our development program, we reserve the right to alter or amend any of the specifications without giving prior notice.

Dimensions for FOOT MOUNTED MOTORS - IM B3

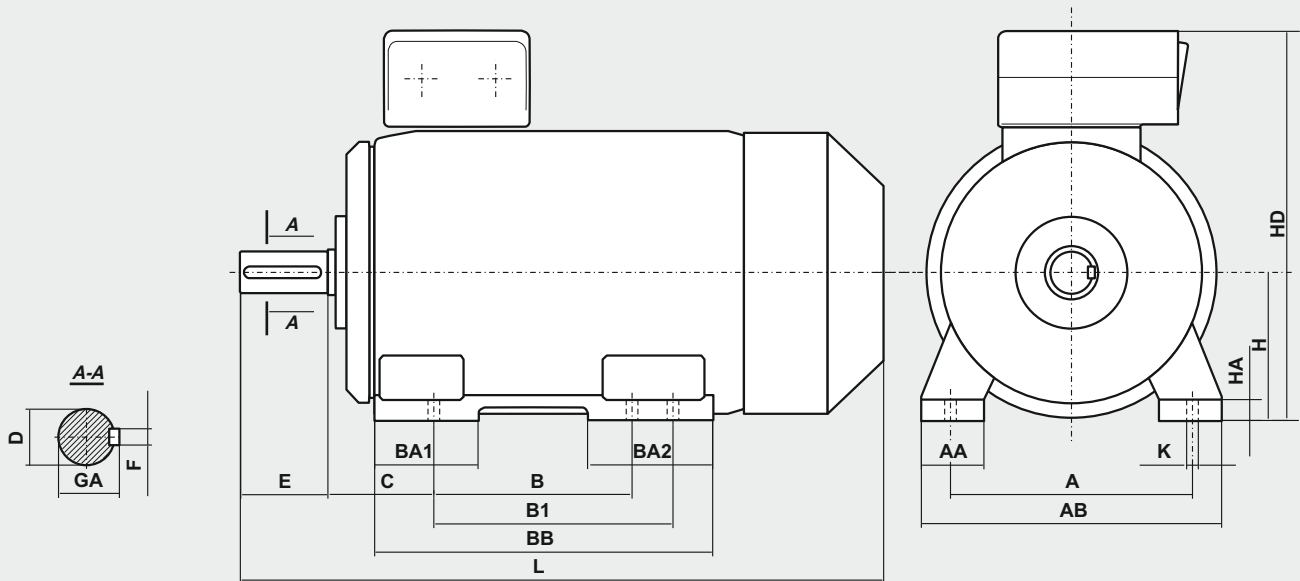
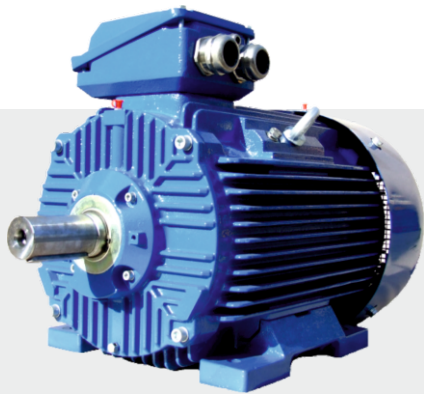

Motor type	A	B	B1	C	D	E	F	GA	H	HA	K	AA	AB	BA1	BA2	BB	HD	L
3SIE200	318	305	-	133	55	110	16	59	200	32	19	80	400	113	113	380	520	850
3SIE225S4	356	286	311	149	60	140	18	64	225	34	19	85	440	115	115	380	570	930
3SIE225M2	356	286	311	149	55	110	16	59	225	34	19	85	440	115	115	380	570	900
3SIE225M4-6	356	286	311	149	60	140	18	64	225	34	19	85	440	115	115	380	570	930
3SIE250M2	406	349	-	168	60	140	18	64	250	37	24	90	480	135	135	445	635	1010
3SIE250M4-6	406	349	-	168	65	140	18	69	250	37	24	90	480	135	135	445	635	1040
3SIE280S2	457	368	419	190	65	140	18	69	280	40	24	105	550	130	165	520	720	1135
3SIE280S4-6	457	368	419	190	75	140	20	79,5	280	40	24	105	550	130	165	520	720	1135
3SIE280M2	457	368	419	190	65	140	18	69	280	40	24	105	550	130	165	520	720	1135
3SIE280M4-6	457	368	419	190	75	140	20	79,5	280	40	24	105	550	130	165	520	720	1135
3SIE315S2	508	406	457	216	65	140	18	69	315	48	28	120	610	160	160	565	805	1235
3SIE315S4-6	508	406	457	216	80	170	22	85	315	48	28	120	610	160	160	565	805	1265
3SIE315M2A;B	508	406	457	216	65	140	18	69	315	48	28	120	610	160	160	565	805	1235
3SIE315M4A;B;6A	508	406	457	216	80	170	22	85	315	48	28	120	610	160	160	565	805	1265
3SIE280M6B	508	406	457	216	80	170	22	85	315	48	28	135	610	135	205	600	805	1355
3SIE315M2C	508	406	457	216	70	140	20	74,5	315	48	28	135	610	135	205	600	805	1290
3SIE315M4C	508	406	457	216	80	170	22	85	315	48	28	135	610	135	205	600	805	1320
3SIE315M6C	508	406	457	216	80	170	22	85	315	48	28	135	610	135	205	600	805	1320
3SIE315M6D	508	406	457	216	90	170	25	95	315	48	28	135	610	135	205	600	805	1320
3SIE 355 ML (2)	610	560	630	254	80	170	22	85	355	50	28	150	720	250	300	890	935	1580
3SIE 355 ML (4, 6)	610	560	630	254	100	210	28	106	355	50	28	150	720	250	300	890	935	1620
3SIE 355 H (2)	610	900	-	200	70	140	20	74,5	355	45	28	160	730	265	265	1045	995	1800
3SIE 355 H (4, 6)	610	900	-	200	100	210	28	106	355	45	28	160	730	265	265	1045	995	1870

Dimensions for FOOT MOUNTED MOTORS - IM B3

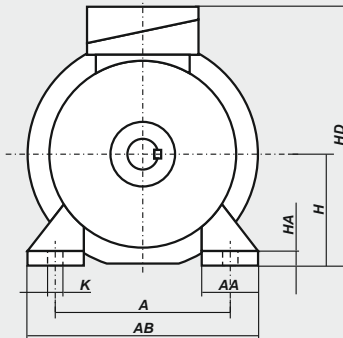
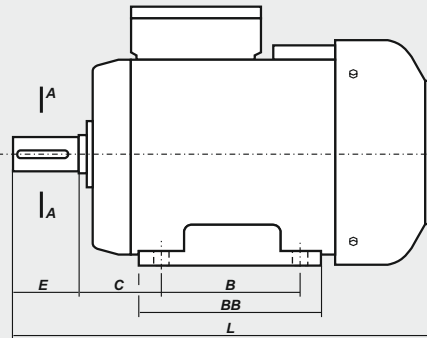
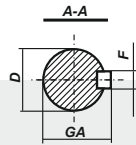

Motor type	A	B	C	D	E	F	GA	H	K	AA	AB	BB	HA	HD	L
DPIH 56-A	90	71	36	9j6	20	3h9	10,2	56	5,8	30	110	92	7	154	183
DPIH 56-B	90	71	36	9j6	20	3h9	10,2	56	5,8	30	110	92	7	154	193
DPIH 63-A	100	80	40	11j6	23	4h9	12,5	63	7	36	124	106	8,5	165	200
DPIH 63-B	100	80	40	11j6	23	4h9	12,5	63	7	36	124	106	8,5	165	210
DPIH 71-A	112	90	45	14j6	30	5h9	16	71	7	45	142	116	8	182	223
DPIH 71-B	112	90	45	14j6	30	5h9	16	71	7	45	142	116	8	182	245
DPIH 80-A	125	100	50	19j6	40	6h9	21,5	80	10	55	160	130	9	200	266
DPIH 80-B	125	100	50	19j6	40	6h9	21,5	80	10	55	160	130	9	200	278
3SIE 80-A	125	100	50	19j6	40	6h9	21,5	80	10	55	160	130	9	199	278
3SIE 80-B	125	100	50	19j6	40	6h9	21,5	80	10	55	160	130	9	199	306
3SIE 90S-2,4,6	140	100	56	24j6	50	8h9	27	90	10	47	182	153	10	238	331
3SIE 90L-2	140	125	56	24j6	50	8h9	27	90	10	47	182	153	10	238	331
3SIE 90L-4,6	140	125	56	24j6	50	8h9	27	90	10	47	182	153	10	238	356
3SIE 100L-2,6	160	140	63	28j6	60	8h9	31	100	12	52	202	170	12	257	377
3SIE 100L-4A,4B	160	140	63	28j6	60	8h9	31	100	12	52	202	170	12	257	417
3SIE 112M-2,6	190	140	70	28j6	60	8h9	31	112	12	52	222	170	14	280	398
3SIE 112M-4	190	140	70	28j6	60	8h9	31	112	12	52	222	170	14	280	425
3SIE 132S	216	140	89	38k6	80	10h9	41	132	12	61	266	220	18	329	512
3SIE 132M	216	178	89	38k6	80	10h9	41	132	12	61	266	220	18	329	512
3SIE 160M	254	210	108	42k6	110	12h9	45	160	15	81	320	300	25	383	643
3SIE 160L	254	254	108	42k6	110	12h9	45	160	15	81	320	300	25	383	643
3SIE 180M-2,4	279	241	121	48k6	110	14h9	51,5	180	15	92	353	320	27	414	723
3SIE 180L-4,6	279	279	121	48k6	110	14h9	51,5	180	15	92	353	320	27	414	723

MOTORS series DPIH and DPIG 2p=8

Motor type	A	B	C	D	E	F	GA	H	HA	K	AA	AB	BB	HD	L
DPIH 90S ...	140	100	56	24j6	50	8h9	27	90	10	10	50	170	153	220	305
DPIH 90L ...	140	125	56	24j6	50	8h9	27	90	10	10	50	170	153	220	330
DPIG 100L ...	160	140	63	28j6	60	8h9	31	100	14	12	45	200	172	240	376
DPIG 112M ...	190	140	70	28j6	60	8h9	31	112	14	12	54	230	174	276	384
2DPIG 132S ...	216	140	89	38k6	80	10h9	41	132	16	12	56	278	182	310	463
2DPIG 132SB/2	216	140	89	38k6	80	10h9	41	132	16	12	56	278	220	310	501
DPIG 132M ...	216	178	89	38k6	80	10h9	41	132	16	12	56	278	220	310	501
DPIG 160M ...	254	210	108	42k6	110	12h9	45	160	20	15	60	305	256	370	612
DPIG 160L ...	254	254	108	42k6	110	12h9	45	160	20	15	60	305	300	370	656
DPIG 180M ...	279	241	121	48k6	110	14h9	51,5	180	26	15	70	350	320	408	705
DPIG 180L ...	279	279	121	48k6	110	14h9	51,5	180	26	15	70	350	320	408	705

Dimensions for FOOT MOUNTED MOTORS - IM B3

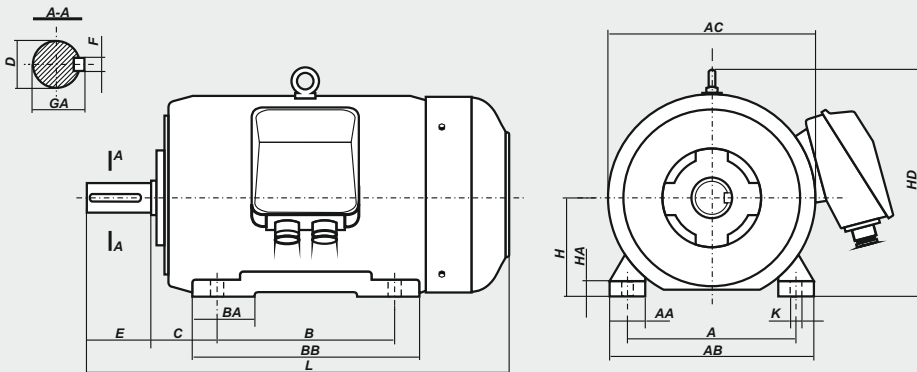

Motor type	A	B	C	D	E	F	GA	H	HA	K	AA	AB	AC	BA	BB	HD	L
2DPIG200L8-12	318	305	133	55m6	110	16h9	59	200	32	19	80	400	450	100	380	485	825
2DPIG225S8-12	356	286	149	60m6	140	18h9	64	225	34	19	85	445	505	110	355	535	865
2DPIG225M8-12	356	311	149	60m6	140	18h9	64	225	34	19	85	445	505	110	380	535	890
2DPIG250M8-12	406	349	168	65m6	140	18h9	69	250	36	24	90	495	540	120	420	590	965
2DPIG280S8-12	457	368	190	75m6	140	20h9	79,5	280	40	24	100	560	620	165	520	660	1040
2DPIG280M8-12	457	419	190	75m6	140	20h9	79,5	280	40	24	100	560	620	165	520	660	1040
DPIG315S8-12	508	406	216	80m6	170	22h9	85	315	46	28	105	610	620	190	560	695	1210
DPIG315M8-12	508	457	216	80m6	170	22h9	85	315	46	28	105	610	620	190	560	695	1210

Dimensions for FOOT MOUNTED MOTORS - IM B3

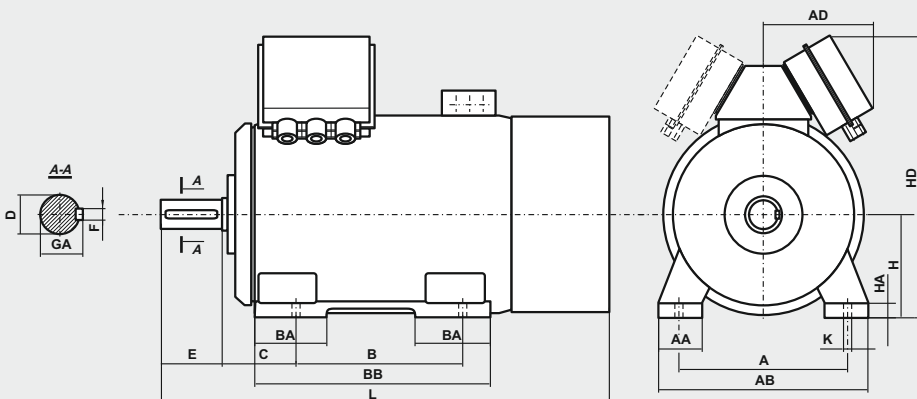

Motor type	Poles	A	B	C	D	E	F	GA	H	HA	K	AA	AB	AD	BA	BB	HD	L
Sh 355...s	2	610	900	200	70	140	20	74,5	355	45	28	160	730	-	265	1045	995	1800
Sh 355...s	4÷8	610	900	200	100	210	28	106	355	45	28	160	730	-	265	1045	995	1870
Sh 400...s	2	686	1000	224	80	170	22	85	400	50	35	175	840	520	265	1160	1255	1980
Sh 400...s	4÷8	686	1000	224	110	210	28	116	400	50	35	175	840	520	265	1160	1255	1960
Sh 450...s	4÷12	750	1120	254	110	210	28	116	450	60	35	205	940	560	340	1320	1356	2105
Sh 500...s	4÷10	850	1250	280	120	210	32	127	500	70	42	223	1050	560	300	1450	1470	2430

Dimensions for FLANGE MOUNTED MOTORS - IM B5, IM V1

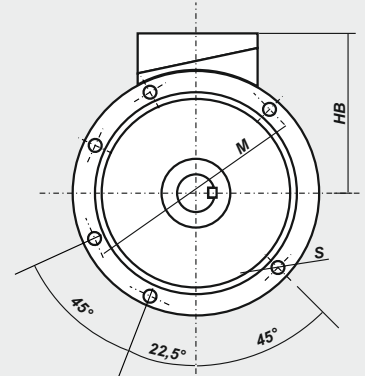
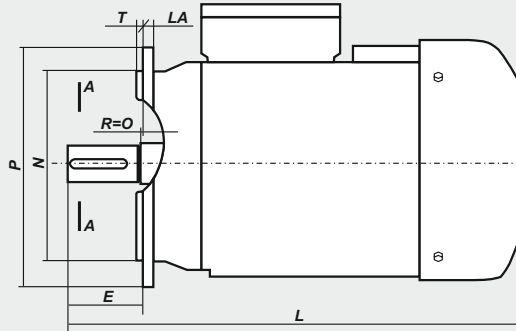
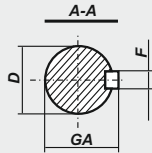
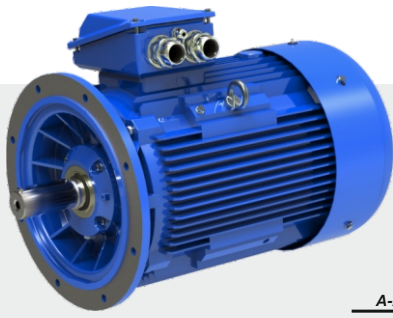

Motor type	D	E	F	GA	M	N	P	LA	T	HB	L	S (f)	S (holes)
DPIH 56-.A	9j6	20	3h9	10,2	100	80j6	120	8	3	98	183	7	4
DPIH 56-.B	9j6	20	3h9	10,2	100	80j6	120	8	3	98	193	7	4
DPIH 63-.A	11j6	23	4h9	12,5	115	95j6	140	9	3	102	200	10	4
DPIH 63-.B	11j6	23	4h9	12,5	115	95j6	140	9	3	102	210	10	4
DPIH 71-.A	14j6	30	5h9	16	130	110j6	160	9	3,5	111	223	10	4
DPIH 71-.B	14j6	30	5h9	16	130	110j6	160	9	3,5	111	245	10	4
DPIH 80-.A	19j6	40	6h9	21,5	165	130j6	200	10	3,5	120	266	12	4
DPIH 80-.B	19j6	40	6h9	21,5	165	130j6	200	10	3,5	120	278	12	4
3SIEK 80-.A	19j6	40	6h9	21,5	165	130j6	200	10	3,5	119	278	12	4
3SIEK 80-.B	19j6	40	6h9	21,5	165	130j6	200	10	3,5	119	306	12	4
3SIEK 90S-2,4,6,L2	24j6	50	8h9	27	165	130j6	200	8	3,5	148	331	12	4
3SIEK 90L-4,6	24j6	50	8h9	27	165	130j6	200	8	3,5	148	356	12	4
3SIEK 100L-2,6	28j6	60	8h9	31	215	180j6	250	11	4	157	377	15	4
3SIEK 100L-4A,4B	28j6	60	8h9	31	215	180j6	250	11	4	157	417	15	4
3SIEK 112M-2,6	28j6	60	8h9	31	215	180j6	250	12	4	168	398	15	4
3SIEK 112M-4	28j6	60	8h9	31	215	180j6	250	12	4	168	425	15	4
3SIEK 132S	38k6	80	10h9	41	265	230j6	300	12	4	197	512	15	4
3SIEK 132M	38k6	80	10h9	41	265	230j6	300	12	4	197	512	15	4
3SIEK 160M	42k6	110	12h9	45	300	250j6	350	13	5	223	643	19	4
3SIEK 160L	42k6	110	12h9	45	300	250j6	350	13	5	223	643	19	4
3SIEK 180M-2,4	48k6	110	14h9	51,5	300	250j6	350	13	5	234	723	19	4
3SIEK 180L-4,6	48k6	110	14h9	51,5	300	250j6	350	13	5	234	723	19	4
3SIEK 200	55	110	16	59	350	300	400	16,5	5	320	850	19	4
3SIEK 225S4	60	140	18	64	400	350	450	18	5	345	930	19	8
3SIEK 225M2	55	110	16	59	400	350	450	18	5	345	900	19	8
3SIEK 225M4-6	60	140	18	64	400	350	450	18	5	345	930	19	8
3SIEK 250M2	60	140	18	64	500	450	550	23	5	385	1010	19	8
3SIEK 250M4-6	65	140	18	69	500	450	550	23	5	385	1040	19	8
3SIEK 280S2	65	140	18	69	500	450	550	23	5	440	1135	19	8
3SIEK 280S4-6	75	140	20	79,5	500	450	550	23	5	440	1135	19	8
3SIEK 280M2	65	140	18	69	500	450	550	23	5	440	1135	19	8
3SIEK 280M4-6	75	140	20	79,5	500	450	550	23	5	440	1135	19	8
3SIEK 315S2*	65	140	18	69	600	550	660	23	6	490	1235	24	8
3SIEK 315S4-6*	80	170	22	85	600	550	660	23	6	490	1265	24	8
3SIEK 315M2A;B*	65	140	18	69	600	550	660	23	6	490	1235	24	8
3SIEK 315M4A;B;6A*	80	170	22	85	600	550	660	23	6	490	1265	24	8
3SIEK 315M6B*	80	170	22	85	600	550	660	23	6	490	1355	24	8
3SIEK 315M2C*	70	140	20	74,5	600	550	660	23	6	490	1290	24	8
3SIEK 315M4C*	80	170	22	85	600	550	660	23	6	490	1320	24	8
3SIEK 315M6C*	80	170	22	85	600	550	660	23	6	490	1320	24	8
3SIEK 315M6D*	90	170	25	95	600	550	660	23	6	490	1320	24	8
3SIEK 355 ML (4 - 6)*	100m6	210	28h9	106	740	680	800	24	6	580	1620	22	8
3SIEK 355 H (4 - 6)*	100m6	210	28h9	106	740	680	800	24	6	638	1955	22	8
SVEE 355ML8*	100	210	28	106	740	680	800	24	6	580	1620	22	8

* only in vertical position IM V1

Dimensions for FLANGE MOUNTED MOTORS - IM B5, IM V1
MOTORS series DPIH and (2)DPIG 2p=8

Type of motor	D	E	F	GA	M	N	P	LA	T	S	HB	L
DPIH 90S ...	24j6	50	8h9	27	165	130j6	200	8	3,5	12	130	305
DPIH 90L ...	24j6	50	8h9	27	165	130j6	200	8	3,5	12	130	330
DPIG 100L ...	28j6	60	8h9	31	215	180j6	250	11	4	15	140	376
DPIG 112M ...	28j6	60	8h9	31	215	180j6	250	12	4	15	164	384
2DPIG 132S ...	38k6	80	10h9	41	265	230j6	300	12	4	15	178	463
2DPIG 132SB/2	38k6	80	10h9	41	265	230j6	300	12	4	15	178	501
2DPIG 132M ...	38k6	80	10h9	41	265	230j6	300	12	4	15	178	501
DPIG 160M ...	42k6	110	12h9	45	300	250j6	350	13	5	19	210	612
DPIG 160L ...	42k6	110	12h9	45	300	250j6	350	13	5	19	210	656
DPIG 180M ...	48k6	110	14h9	51,5	300	250j6	350	13	5	19	228	705

Dimensions for FLANGE MOUNTED MOTORS - IM B5, IM V1

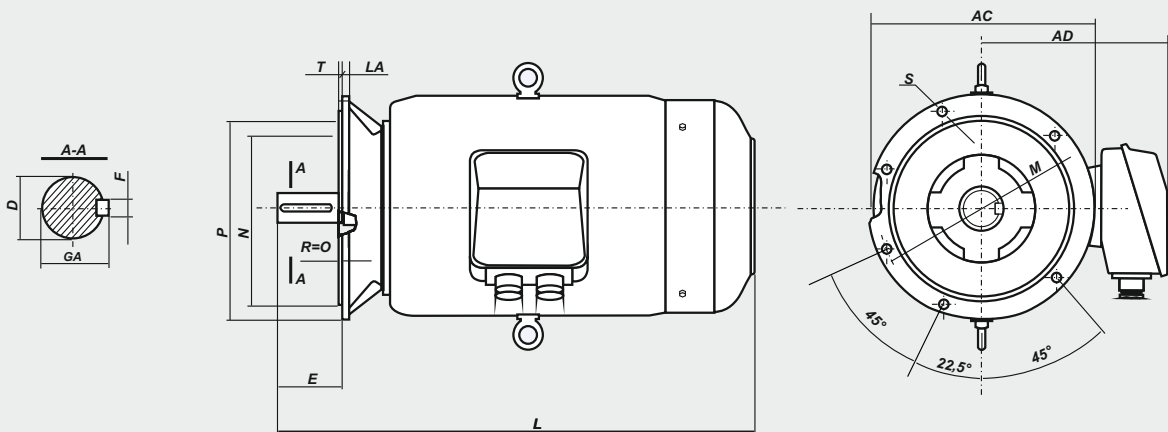

Motor type	D	E	F	GA	AC	AD	L	LA	M	N	P	T	S	Holes
2DPIG 200 L8-12	55m6	110	16h9	59	450	340	825	16,5	350	300j6	400	5	18	4
2DPIG 225 S8-12	60m6	140	18h9	64	505	360	865	18	400	350j6	450	5	18	8
2DPIG 225 M8-12	60m6	140	18h9	64	505	360	890	18	400	350j6	450	5	18	8
2DPIG 250 M8-12	65m6	140	18h9	69	540	405	965	19	500	450j6	550	5	18	8
2DPIG 280 S8-12	75m6	140	20h9	79,5	620	440	1040	20	500	450j6	550	5	18	8
2DPIG 280 M8-12	75m6	140	20h9	79,5	620	440	1040	20	500	450j6	550	5	18	8
DPIG 315 S8-12	80m6	170	22h9	85	620	440	1210	22	600	550j6	660	6	22	8
DPIG 315 M8-12	80m6	170	22h9	85	620	440	1210	22	600	550j6	660	6	22	8

Dimensions for FLANGE MOUNTED MOTORS - IM B5, IM V1

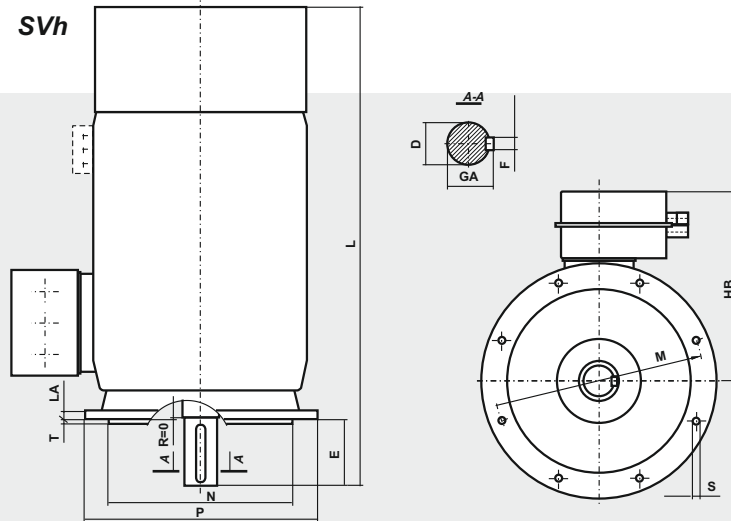

Motor type	Poles	D	E	F	GA	HB	L	LA	M	N	P	S	T
SVh 355...s*	4+8	100	210	28	106	640	1955	24	740	680	800	22	6
SVh 400...s*	4+8	110	210	28	116	725	2016	37	940	880	1000	23	6
SVh 450...s*	4+12	110	210	28	116	835	2162	30	1080	1000	1150	28	6
SVh 500...s*	4+12	120	210	32	127	835	2505	30	1080	1000	1150	28	6

* - the SVh motors may operate only in vertical position IM V1.

Dimensions for FOOT/FLANGE MOUNTED MOTORS - IM B35

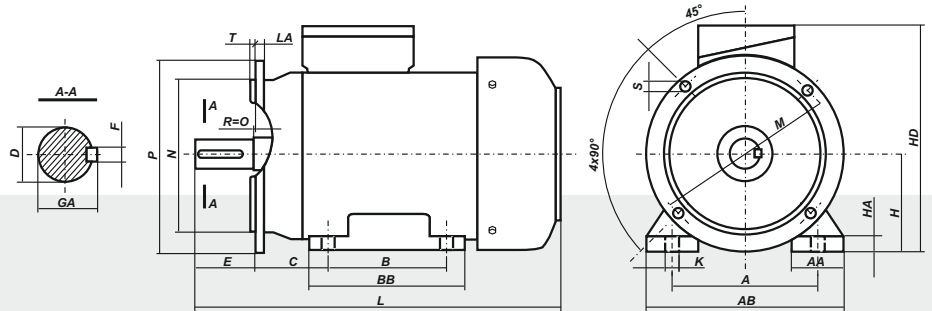
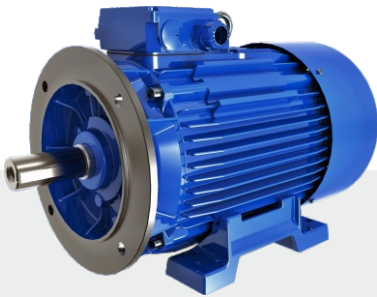

Motor type	A	B	C	D	E	F	GA	H	K	M	N	P	S	LA	T	AA	AB	BB	HA	HD	L
DPIH 56-A	90	71	36	9j6	20	3h9	10,2	56	8	100	80j6	120	7	8	3	30	110	92	7	154	183
DPIH 56-B	90	71	36	9j6	20	3h9	10,2	56	8	100	80j6	120	7	8	3	30	110	92	7	154	193
DPIH 63-A	100	80	40	11j6	23	4h9	12,5	63	10	115	95j6	140	10	9	3	36	124	106	8,5	165	200
DPIH 63-B	100	80	40	11j6	23	4h9	12,5	63	10	115	95j6	140	10	9	3	36	124	106	8,5	165	210
DPIH 71-A	112	90	45	14j6	30	5h9	16	71	10	130	110j6	160	10	9	3,5	45	142	116	8	182	223
DPIH 71-B	112	90	45	14j6	30	5h9	16	71	10	130	110j6	160	10	9	3,5	45	142	116	8	182	245
DPIH 80-A	125	100	50	19j6	40	6h9	21,5	80	10	165	130j6	200	12	10	3,5	55	160	130	9	200	266
DPIH 80-B	125	100	50	19j6	40	6h9	21,5	80	10	165	130j6	200	12	10	3,5	55	160	130	9	200	278
3SIEL 80-A	125	100	50	19j6	40	6h9	21,5	80	10	165	130j6	200	12	10	3,5	55	160	130	9	200	278
3SIEL 80-B	125	100	50	19j6	40	6h9	21,5	80	10	165	130j6	200	12	10	3,5	55	160	130	9	200	306
3SIEL 90S-2,4,6	140	100	56	24j6	50	8h9	27	90	10	165	130j6	200	12	8	3,5	47	182	153	10	238	331
3SIEL 90L-2	140	125	56	24j6	50	8h9	27	90	10	165	130j6	200	12	8	3,5	47	182	153	10	238	331
3SIEL 90L-4,6	140	125	56	24j6	50	8h9	27	90	10	165	130j6	200	12	8	3,5	47	182	153	10	238	356
3SIEL 100L-2,6	160	140	63	28j6	60	8h9	31	100	12	215	180j6	250	15	11	4	52	202	170	12	257	377
3SIEL 100L-4A,4B	160	140	63	28j6	60	8h9	31	100	12	215	180j6	250	15	11	4	52	202	170	12	257	417
3SIEL 112M-2,6	190	140	70	28j6	60	8h9	31	112	12	215	180j6	250	15	12	4	52	222	170	14	280	398
3SIEL 112M-4	190	140	70	28j6	60	8h9	31	112	12	215	180j6	250	15	12	4	52	222	170	14	280	425
3SIEL 132S	216	140	89	38k6	80	10h9	41	132	12	265	230j6	300	15	12	4	61	266	220	18	329	512
3SIEL 132M	216	178	89	38k6	80	10h9	41	132	12	265	230j6	300	15	12	4	61	266	220	18	329	512
3SIEL 160M	254	210	108	42k6	110	12h9	45	160	15	300	250j6	350	19	13	5	81	320	200	25	383	643
3SIEL 160L	254	254	108	42k6	110	12h9	45	160	15	300	250j6	350	19	13	5	81	320	200	25	383	643
3SIEL 180M	279	241	121	48k6	110	14h9	51,5	180	15	300	250j6	350	19	13	5	92	353	320	27	414	723
3SIEL 180L	279	279	121	48k6	110	14h9	51,5	180	15	300	250j6	350	19	13	5	92	353	320	27	414	723

Dimensions for FOOT/FLANGE MOUNTED MOTORS - IM B35

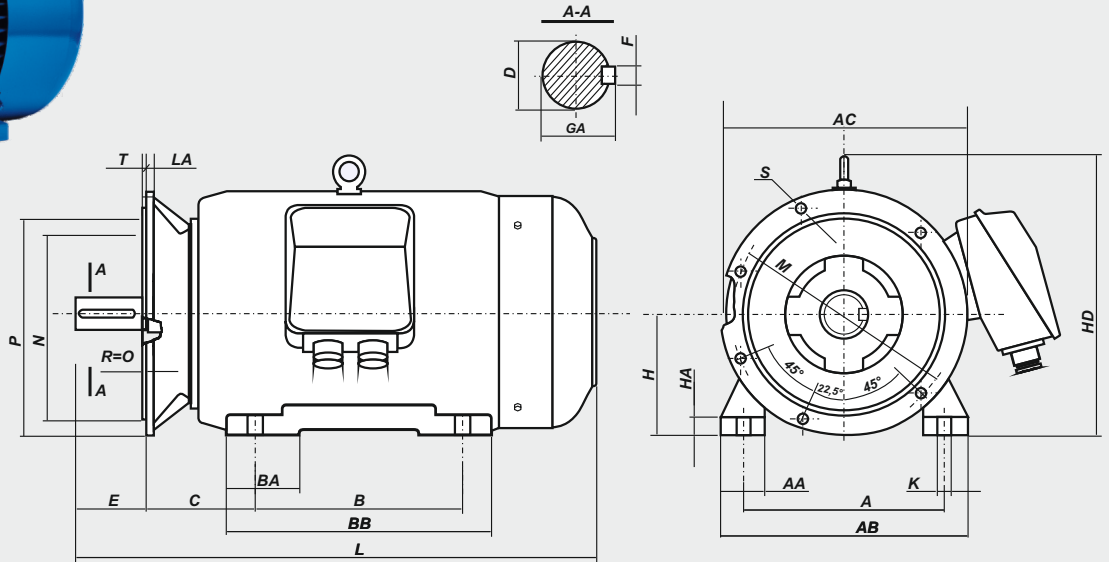

Motor type	A	B	C	D	E	F	GA	H	HA	K	AA	AB	AC	BA	BB	HD	L	LA	M	N	P	T	S	φ Holes
2DPIG200 L8-12	318	305	133	55m6	110	16h9	59	200	32	19	80	400	450	100	380	485	825	16,5	350	300	400	5	18	4
2DPIG225 S8-12	356	286	149	60m6	140	18h9	64	225	34	19	85	445	505	110	355	535	865	18	400	350	450	5	18	8
2DPIG225 M8-12	356	311	149	60m6	140	18h9	64	225	34	19	85	445	505	110	380	535	890	18	400	350	450	5	18	8
2DPIG250 M8-12	406	349	168	65m6	140	18h9	69	250	36	24	90	495	540	120	420	590	965	19	500	450	550	5	18	8
2DPIG280 S8-12	457	368	190	75m6	140	20h9	79,5	280	40	24	100	560	620	165	520	660	1040	20	500	450	550	5	18	8
2DPIG280 M8-12	457	419	190	75m6	140	20h9	79,5	280	40	24	100	560	620	165	520	660	1040	20	500	450	550	5	18	8
DPIG315 S8-12	508	406	216	80m6	170	22h9	85	315	46	28	105	610	620	190	560	695	1210	22	600	550	660	6	22	8
DPIG315 M8-12	508	457	216	80m6	170	22h9	85	315	46	28	105	610	620	190	560	695	1210	22	600	550	660	6	22	8

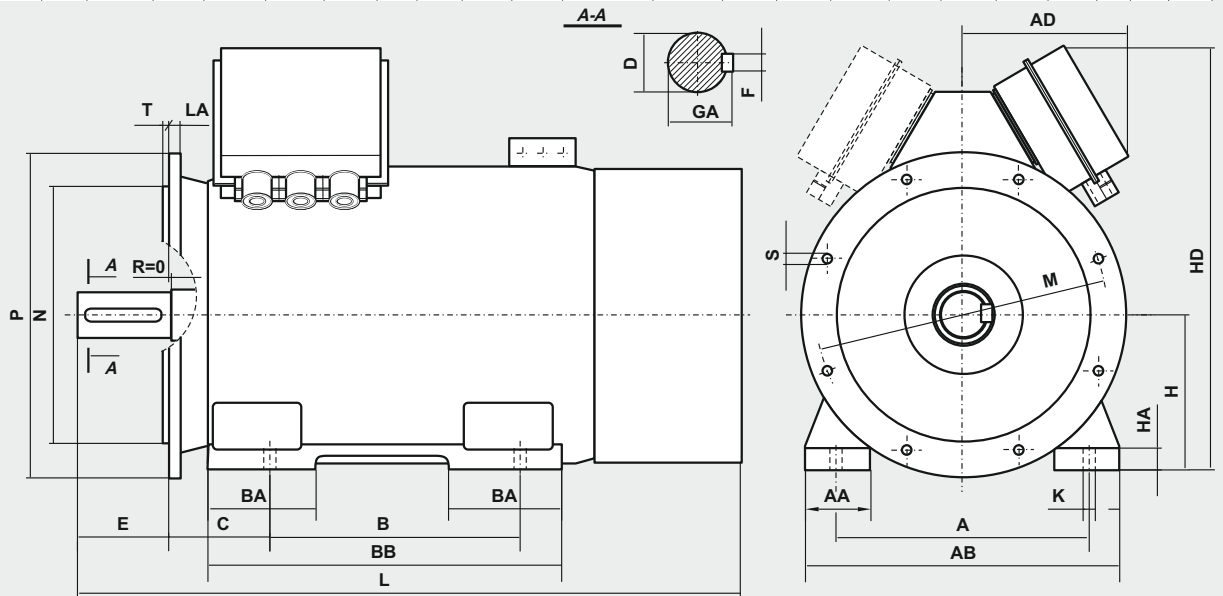

Type of motor	Poles	A	B	C	D	E	F	GA	H	HA	K	AA	AB	AD	BA	BB	HD	L	LA	M	N	P	S	T
SLh 355...s	2	610	900	254	70	140	20	74.5	355	45	28	160	730	344	265	1045	995	1854	24	740	680	800	22	6
SLh 355...s	4+8	610	900	254	100	210	28	106	355	45	28	160	730	344	265	1045	995	1924	24	740	680	800	22	6
SLh 400...s	2	686	1000	280	80	170	22	85	400	50	35	175	840	520	265	1160	1255	2031	30	940	880	1000	25	6
SLh 400...s	4+8	686	1000	280	110	210	28	116	400	50	35	175	840	520	265	1160	1255	2016	30	940	880	1000	25	6
SLh 450...s	4+12	750	1120	315	110	210	28	116	450	60	35	205	940	560	340	1320	1356	2162	30	1080	1000	1150	28	6
SLh 500...s	4+10	850	1250	355	120	210	32	127	500	70	42	223	1050	560	300	1450	1470	2505	30	1080	1000	1150	28	6

Dimensions for FLANGE MOUNTED MOTORS - IM B14

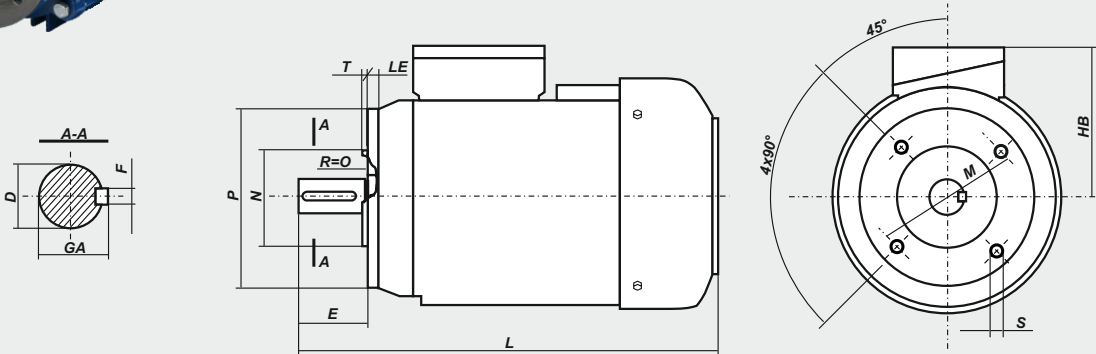

Motor type	Flange	D	E	F	GA	M	N	P	S	T	LE	HB	L
DPIH 56- .A1	B14/C1	9j6	20	3h9	10,2	85	70j6	105	M6	2,5	15	98	183
DPIH 56- .A2	B14/C2	9j6	20	3h9	10,2	65	50j6	80	M5	2,5	12,5	98	183
DPIH 56- .B1	B14/C1	9j6	20	3h9	10,2	85	70j6	105	M6	2,5	15	98	193
DPIH 56- .B2	B14/C2	9j6	20	3h9	10,2	65	50j6	80	M5	2,5	12,5	98	193
DPIH 63- .A1	B14/C1	11j6	23	4h9	12,5	100	80j6	120	M6	3	14	102	200
DPIH 63- .A2	B14/C2	11j6	23	4h9	12,5	75	60j6	90	M5	2,5	9,5	102	200
DPIH 63- .B1	B14/C1	11j6	23	4h9	12,5	100	80j6	120	M6	3	14	102	210
DPIH 63- .B2	B14/C2	11j6	23	4h9	12,5	75	60j6	90	M5	2,5	9,5	102	210
DPIH 71- .A1	B14/C1	14j6	30	5h9	16	115	95j6	140	M8	3	14	111	223
DPIH 71- .A2	B14/C2	14j6	30	5h9	16	85	70j6	105	M6	2,5	12	111	223
DPIH 71- .B1	B14/C1	14j6	30	5h9	16	115	95j6	140	M8	3	14	111	245
DPIH 71- .B2	B14/C2	14j6	30	5h9	16	85	70j6	105	M6	2,5	12	111	245
DPIH 80- .A1	B14/C1	19j6	40	6h9	21,5	130	110j6	160	M8	3,5	14	120	266
DPIH 80- .A2	B14/C2	19j6	40	6h9	21,5	100	80j6	120	M6	3	12	120	266
DPIH 80- .B1	B14/C1	19j6	40	6h9	21,5	130	110j6	160	M8	3,5	14	120	278
DPIH 80- .B2	B14/C2	19j6	40	6h9	21,5	100	80j6	120	M6	3	12	120	278
3SIEK 80- .A1	B14/C1	19j6	40	6h9	21,5	130	110j6	160	M8	3,5	14	119	278
3SIEK 80- .A2	B14/C2	19j6	40	6h9	21,5	100	80j6	120	M6	3	12	119	306
3SIEK 80- .B1	B14/C1	19j6	40	6h9	21,5	130	110j6	160	M8	3,5	14	119	278
3SIEK 80- .B2	B14/C2	19j6	40	6h9	21,5	100	80j6	120	M6	3	12	119	306
3SIEK 90S 2,4,6,L2	B14/C1	24j6	50	8h9	27	130	110j6	160	M8	3,5	10	148	331
3SIEK 90S 2,4,6,L2	B14/C2	24j6	50	8h9	27	115	95j6	140	M8	3	10	148	331
3SIEK 90L 4,6	B14/C1	24j6	50	8h9	27	130	110j6	160	M8	3,5	10	148	356
3SIEK 90L 4,6	B14/C2	24j6	50	8h9	27	115	95j6	140	M8	3	10	148	356
3SIEK 100L2,6	B14/C1	28j6	60	8h9	31	165	130j6	200	M10	3,5	12	157	377
3SIEK 100L2,6	B14/C2	28j6	60	8h9	31	130	110j6	160	M8	3,5	12	157	377
3SIEK 100L4A,4B	B14/C1	28j6	60	8h9	31	165	130j6	200	M10	3,5	12	157	417
3SIEK 100L4A,4B	B14/C2	28j6	60	8h9	31	130	110j6	160	M8	3,5	12	157	417
3SIEK 112M2,6	B14/C1	28j6	60	8h9	31	165	130j6	200	M10	3,5	12	168	398
3SIEK 112M2,6	B14/C2	28j6	60	8h9	31	130	110j6	160	M8	3,5	12	168	398
3SIEK 112M4	B14/C1	28j6	60	8h9	31	165	130j6	200	M10	3,5	12	168	425
3SIEK 112M4	B14/C2	28j6	60	8h9	31	130	110j6	160	M8	3,5	12	168	425
3SIEK 132S	B14/C1	38k6	80	10h9	41	215	180j6	250	M12	4	12	197	512
3SIEK 132S	B14/C2	38k6	80	10h9	41	165	130j6	200	M10	3,5	12	197	512
3SIEK 132M	B14/C1	38k6	80	10h9	41	215	180j6	250	M12	4	12	197	512
3SIEK 132M	B14/C2	38k6	80	10h9	41	165	130j6	200	M10	3,5	12	197	512

Dimensions for FLANGE MOUNTED MOTORS - IM B14

MOTORS series DPIH and (2)DPIG 2p=8

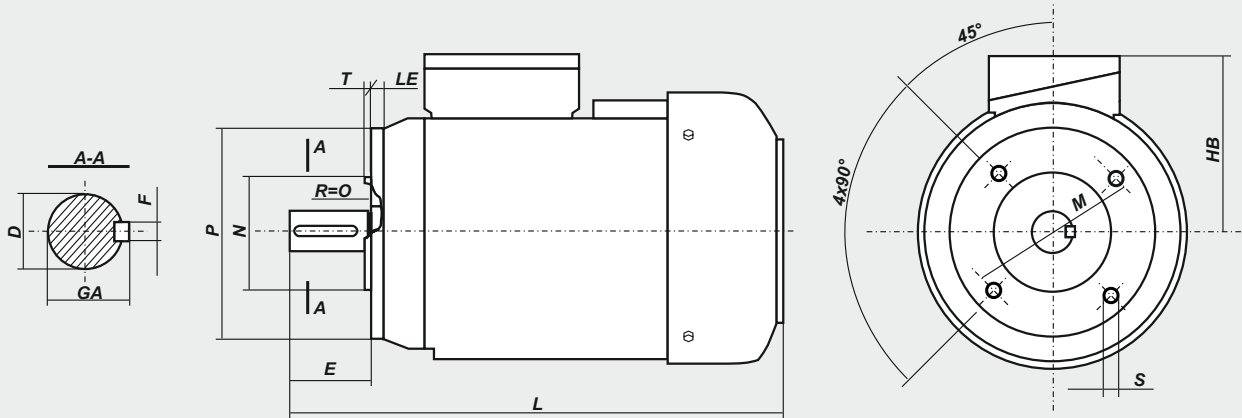

Motor type	Flange	D	E	F	GA	M	N	P	S	T	LE	HB	L
DPIH 90S ...	B14/C2	24j6	50	8h9	27	115	95j6	140	M8	3	10	130	305
DPIH 90L ...	B14/C1	24j6	50	8h9	27	130	110j6	160	M8	3,5	10	130	330
DPIH 90L ...	B14/C2	24j6	50	8h9	27	115	95j6	140	M8	3	10	130	330
DPIG 100L ...	B14/C1	28j6	60	8h9	31	165	130j6	200	M10	3,5	12	140	376
DPIG 100L ...	B14/C2	28j6	60	8h9	31	130	110j6	160	M8	3,5	12	140	376
DPIG 112M ...	B14/C1	28j6	60	8h9	31	165	130j6	200	M10	3,5	12	164	384
DPIG 112M ...	B14/C2	28j6	60	8h9	31	130	110j6	160	M8	3,5	12	164	384
2DPIG 132S ...	B14/C1	38k6	80	10h9	41	215	180j6	250	M12	4	12	178	463
2DPIG 132S ...	B14/C2	38k6	80	10h9	41	165	130j6	200	M10	3,5	12	178	463
2DPIG 132SB/2	B14/C1	38k6	80	10h9	41	215	180j6	250	M12	4	12	178	501
2DPIG 132SB/2	B14/C2	38k6	80	10h9	41	165	130j6	200	M10	3,5	12	178	501
2DPIG 132M ...	B14/C1	38k6	80	10h9	41	215	180j6	250	M12	4	12	178	501
2DPIG 132M ...	B14/C2	38k6	80	10h9	41	165	130j6	200	M10	3,5	12	178	501
DPIG 160M ...	B14/C1	42k6	110	12h9	45	265	230j6	300	M12	4	13	210	612
DPIG 160M...	B14/C2	42k6	110	12h9	45	215	180j6	250	M12	4	20	210	612
DPIG 160L ...	B14/C1	42k6	110	12h9	45	265	230j6	300	M12	4	13	210	656
DPIG 160L ...	B14/C2	42k6	110	12h9	45	215	180j6	250	M12	4	20	210	656

List of Motor parts

Frame Size: 56-80
Motor series 3SIE and DPIH

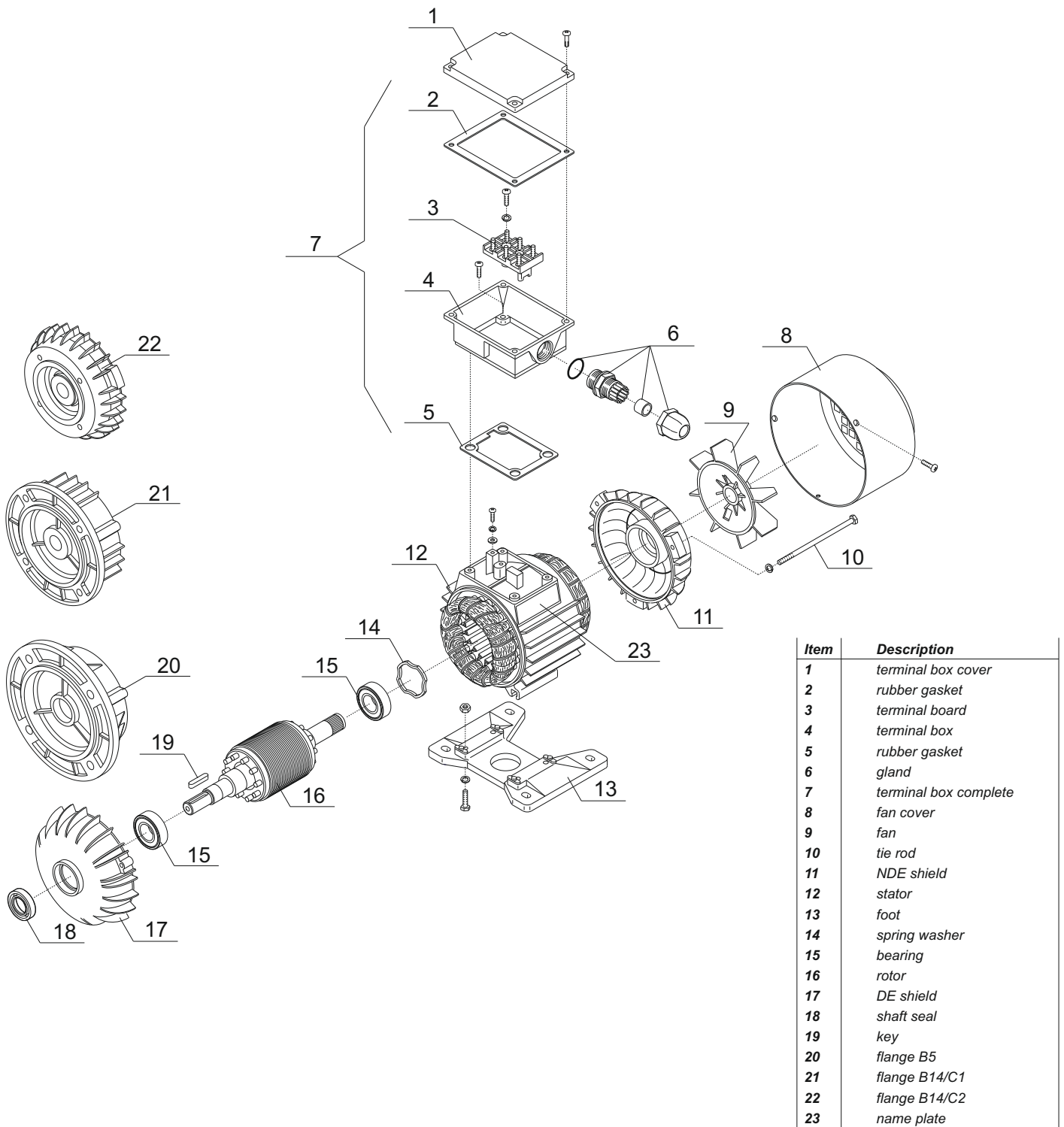

Item	Description
1	terminal box cover
2	rubber gasket
3	terminal board
4	terminal box
5	rubber gasket
6	gland
7	terminal box complete
8	fan cover
9	fan
10	tie rod
11	NDE shield
12	stator
13	foot
14	spring washer
15	bearing
16	rotor
17	DE shield
18	shaft seal
19	key
20	flange B5
21	flange B14/C1
22	flange B14/C2
23	name plate

DE - drive end
NDE - non drive end

Frame Size: 90 ÷ 180
Motor series 3SIE, DPIG and DPIH

List of Motor parts

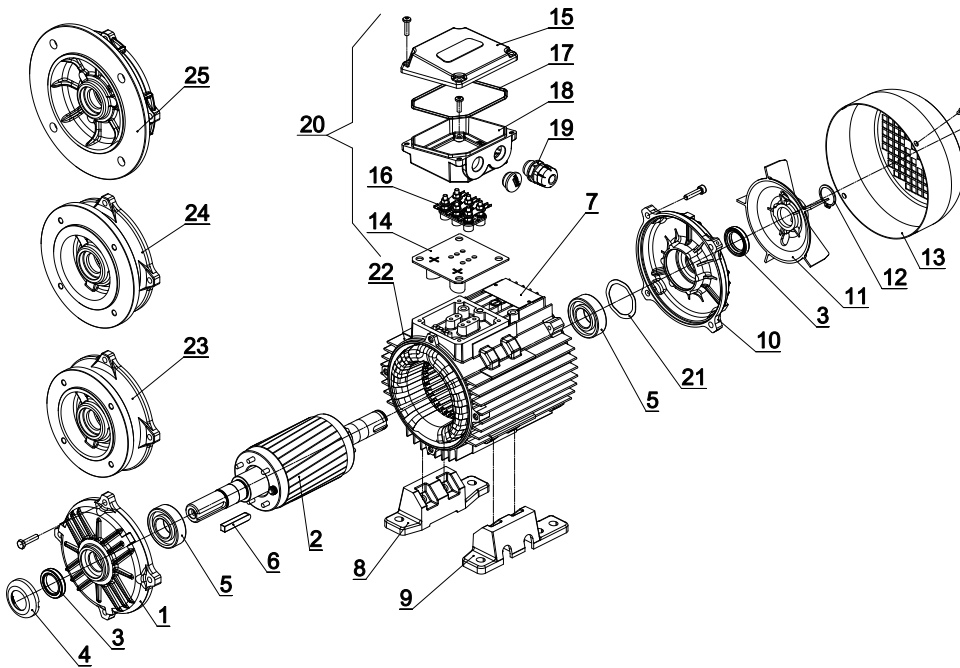

Item	Description
1	DE shield
2	rotor
3	shaft seal
4	shaft seal cover
5	bearing
6	key
7	name plate
8 ¹	sx foot
9 ¹	dx foot
10	NDE shield
11	fan
12	seeger ring
13	fan cover
14	rubber gasket
15	terminal box cover
16	terminal board
17	rubber gasket
18	terminal box
19	glands
20	terminal box complete
21	spring washer
22	stator
23 ²	flange B14/C2
24 ²	flange B14/C1
25	flange B5

1 - for frame size 132 - 180 feet can be screwed or integrated with the motor housing,
 2 - only for frame size 90 - 132.

Item	Description
1	DE shield
2	rotor
3a,b	shaft seal
4a,b	bearing
5	key
6	housing with feet
7a,b	internal bearing cap
8a,b	external bearing cap
9	NDE shield
10	fan
11	seeger ring
12	fan cover
13	terminal box cover
14	terminal board
15	rubber gasket
16	terminal box housing
17	rubber gasket
18	cable glands
19	fan cover support
20	spring washer
21a,b	seeger ring
22a,b	grease shield
23a,b	bearing internal ring
24a,b	grease nipple
25	flange B5
26	rubber gasket

Frame Size: 200 ÷ 355
Motor series 3SIE

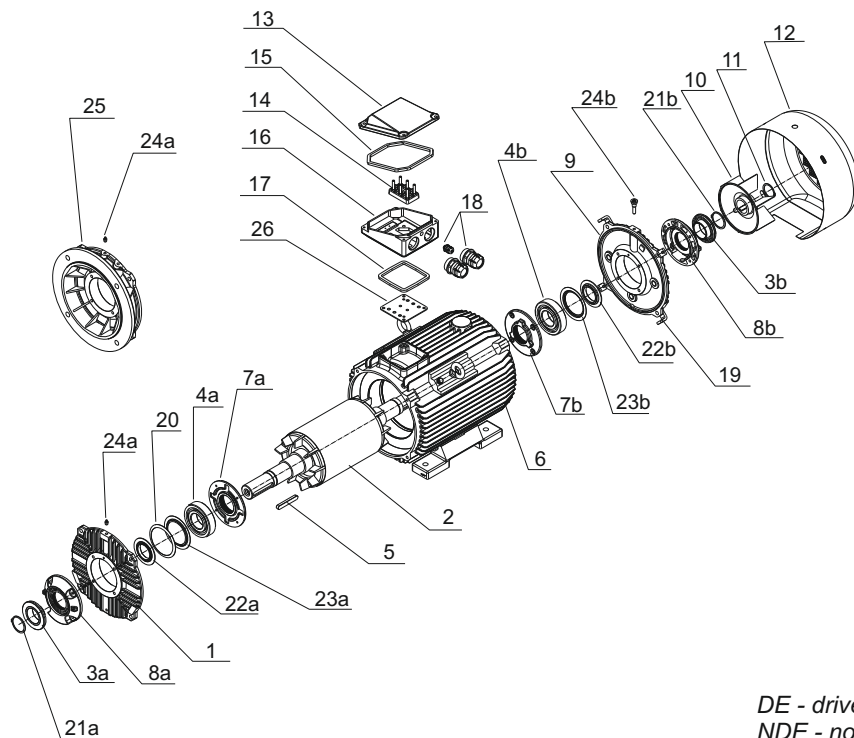

DE - drive end
 NDE - non drive end

Frame Size: 200 ÷ 315
Motor series 2DPIG (2p = 8 ÷ 12)

List of Motor parts

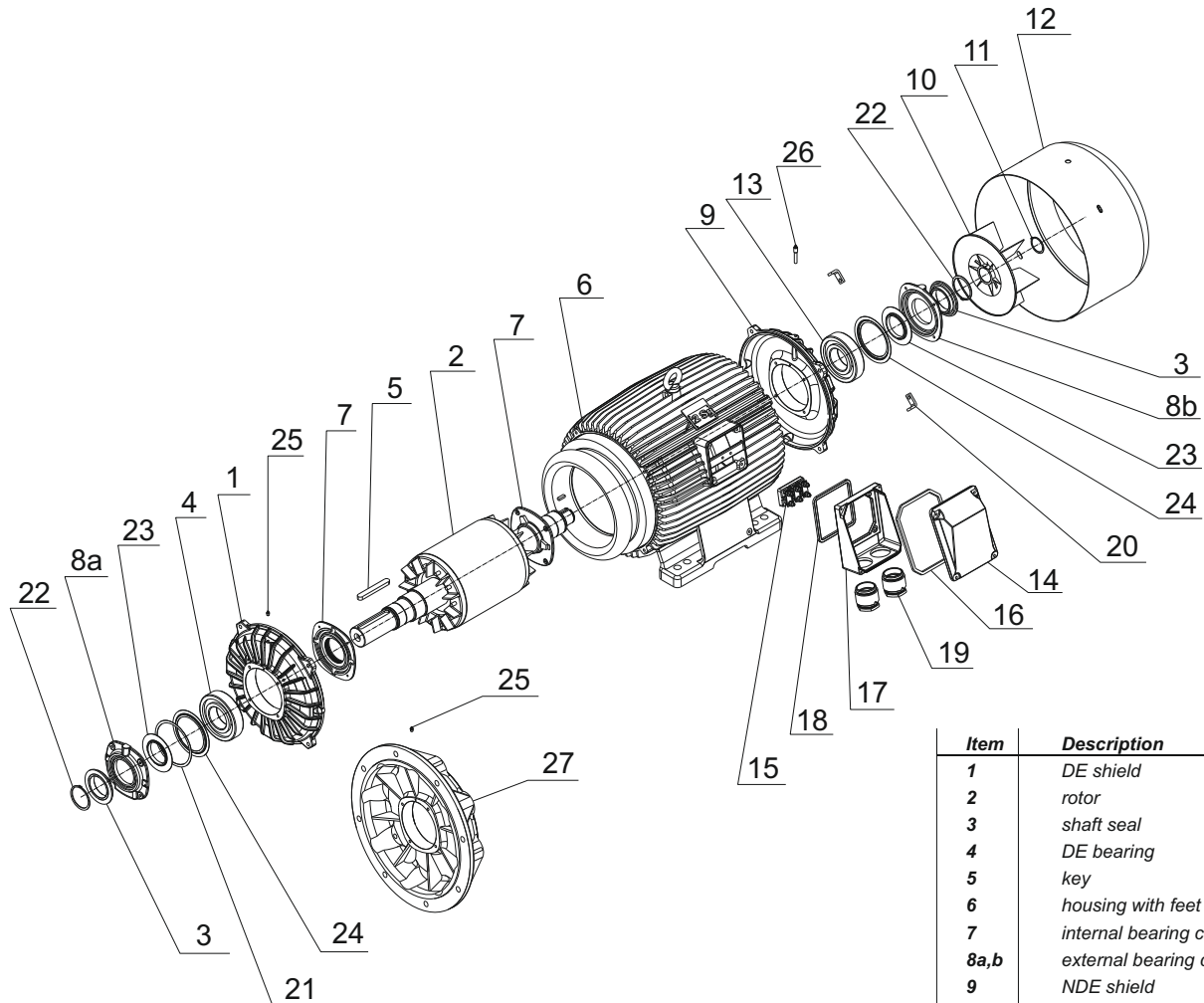





<i>Item</i>	<i>Description</i>
1	DE shield
2	rotor
3	shaft seal
4	DE bearing
5	key
6	housing with feet
7	internal bearing cap
8a,b	external bearing cap
9	NDE shield
10	fan
11	seeger ring
12	fan cover
13	NDE bearing
14	terminal box cover
15	terminal cover support
16	rubber gasket
17	terminal box housing
18	rubber gasket
19	cable glands
20	fan cover support
21	spring washer
22	seeger ring
23	grease shield *
24	bearing internal ring *
25	DE grease nipple
26	NDE grease nipple
27	flange B5









* only for size 315

DE - drive end
 NDE - non drive end

PRODUCT RANGE

GENERAL PURPOSE 3-PHASE INDUCTION MOTORS	Three-phase motors with squirrel-cage rotor series (2)Sg(m), Sh. High efficiency motors series 2SIE, 3SIE and 4SIE (Efficiency classes IE1, IE2, IE3, IE4)	from 0,04kW up to 1400kW	general purpose, pumps, fans, compressors, specific requirements relating to the highest efficiency	
GENERAL PURPOSE 1-PHASE INDUCTION MOTORS	Single-phase motors with squirrel-cage rotor series SEh(R), SEMh(R). - motors with standard starting torque - motors with increased starting torque - motors with high starting torque.	from 0,04kW up to 4kW	general purpose, pumps, fans, compressors, wood machines, machines and devices for food processing, mixers for building	
HIGH VOLTAGE INDUCTION MOTORS	Three-phase squirrel-cage high voltage and high efficiency motors series Sh with cast-iron housing. High voltage motors with module construction (steel/welded housing) series Sf-E and Sfw.	from 160kW up to 3150kW	general industrial use, drives used for own needs of power plants (pumps, fans, coal mills, conveyors)	
BRAKE MOTORS	Three-phase and single-phase brake motors with AC and DC brakes.	from 0,04kW up to 160kW	applied in case of necessity to stop the motor suddenly	
MOTORS WITH FOREIGN COOLING	Three-phase 3-phase induction motors with foreign cooling.	from 0,06kW up to 250kW	drives adapted for speed regulation by frequency converter	
EXPLOSION-PROOF MOTORS	Increased safety motors. Flame-proof motors.	from 0,06kW up to 22kW from 0,75kW up to 315kW	adapted for operation in areas endangered by explosion (without methane) application in an atmosphere where a mixture of explosive gas and vapours may occur	
NEMA MOTORS	Low voltage NEMA motors SIE series (in compliance with the NEMA PREMIUM requirements).	from 1HP up to 250HP	general industrial application, pumps, fans	
TRACTION MOTORS	Traction motors and traction generators.	from 50kW up to 1500kW	various traction vehicles: trams (including low-deck trams), trolleybuses, subway and locomotives	

PRODUCT RANGE

SUBMERSIBLE MOTORS	Submersible motors with protection Ip68 Type TMP	from 5,5kW up to 22kW 4 poles standard with 10m connection cable and 6m protection tube with special shaft (long or short)	PUMP DIRVE Agriculture, liquid manure, biogas, wastewater , sewage plant	
SUBMERSIBLE MOTORS	Special motors desinged and produced from FFD in close coordination with and especially for our customers. From the first idea to the final production.	for example: Submersible motor type: dSKLS (11 and 15kW) flame proof desing IIG Ex dIIA T4	MIXER Agriculture, liquid manure, biogas, wastewater , sewage plant	
HOLLOW SHAFT MOTORS	Three-phase induction motors with hollow shaft	Frame size: 100 up to 250 Poles: 2, 4, 6, 8, 12 and multiple speed	Suitable for agitators driving with special flange and hollow shaft (without propeller and shaft)	
MARINE MOTORS	Three-phase induction motors	PRS - polish register of shipping GL - German Lloyd ´s LRS - Lloyd ´s Register of shipping DNV - Det Norske Veritas ABS - American Bureau of shipping BV - Bureau Veritas RMRS - Russian Maritime Register of Shipping	Motors designed for use on ships. On deck or under deck. The motors are made to withstand aggressive environments such a salt mist.	
MOTORS FOR INDUSTRIAL FURNANCE AND BLOWERS	Three-phase induction motors	Motors used for air circulation up to 1200°C air temperature	Motors works in drying plants	
COOLING MEDIUM PUMPS	Three phase pumps or Single phase pumps	DKP with 115W EKP with 100W Dip length: 86mm, 120mm, 170mm, 220mm, 270mm 220-250/380-440V 50/60Hz	Work like centrifugal pumps. These pumps are quite resistant to the pollution of coolants. Manufactured in with 5 different dip length.	
BREAKS	Electromagnetic breaks	H2SP, HPS, 2H2SP, H2SPX H2SP..AT - quiet operation HPS..AT - quiet operation STE, STK - quiet operation 2H2SP..BT - quiet operation, NE - high level of protection NEX - explosion-proof version HZg - alternating current brakes	High standard and high repeatability even with large number of actuations.	
REPAIRS AND SERVICE	Electrical and mechanical repairs of all motor types Service and testing of all motor types Also motors from other manufacturers	for example: - new winding - new bearings - new shafts - new PTC, Pt100 or bi-metal switch - new painting (all RAL colors) - new name plate - Motor routine test	We are using only high quality materials for motor repair.	

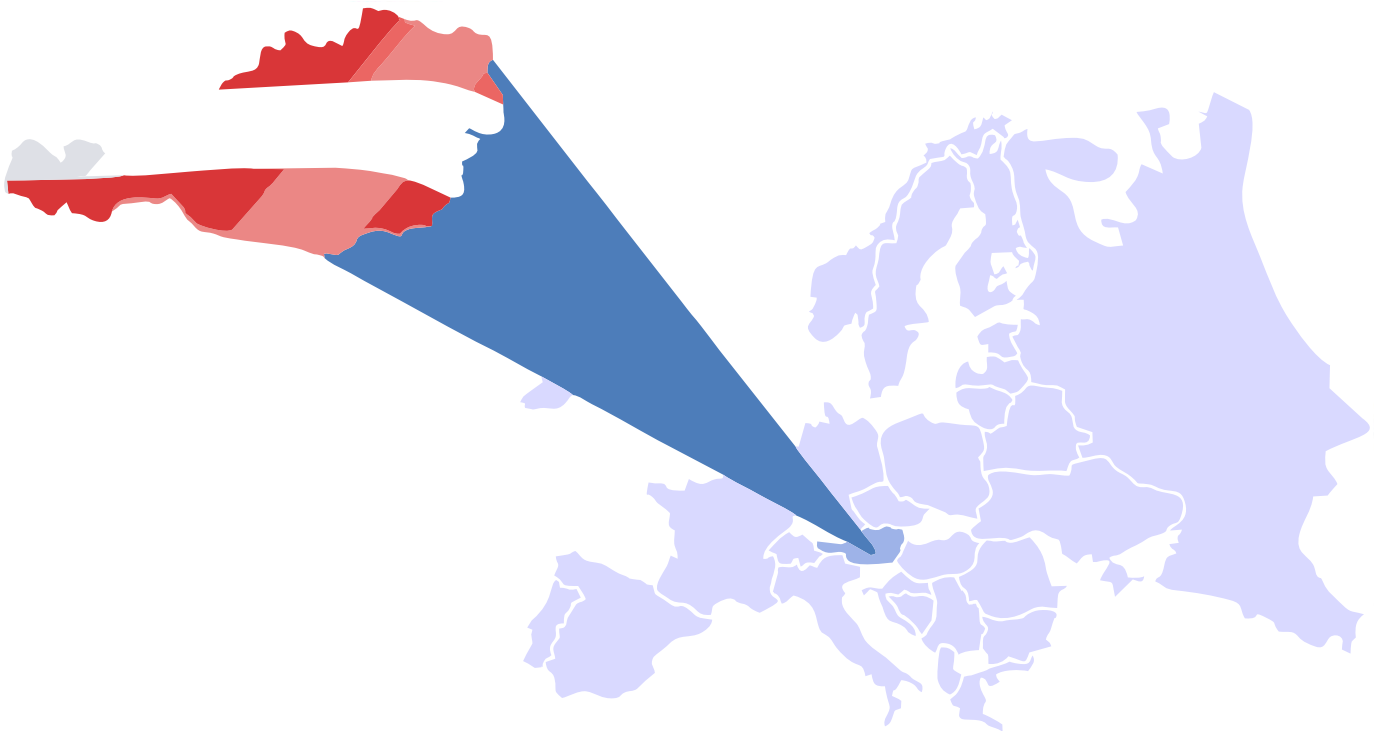

**FFD locadet in the heart
of Europe, AUSTRIA!**

FRANK & DVORAK

Elektromaschinenbau- und Vertriebsgesellschaft m.b.H. u. Co.KG

CONTACT ADDRESS:

Industriestraße 1
7033 Pöttching, AUSTRIA
Phone: +43 2631 8005
FAX: +43 2631 8005 84
mail to: ffd@frank-dvorak.at
www.frank-dvorak.at